



t. (02) 6292 2278
m. 0415 775 477
p. PO BOX 576, Erindale ACT 2903
e. info@actpropertyinspections.com.au
w. www.actpropertyinspections.com.au

ACT Property Report

- Building Report
- Compliance Report
- Conveyancing Report
- Energy Efficiency Rating
- Timber Pest Inspection Report
- Insurance Certificates
- Invoice



68 BARADA CRESCENT ARANDA ACT 2614

Report Prepared: Friday, 17 April 2015

Conclusion and Summary

The purpose of the Inspection is to identify the major defects and safety hazards associated with the property at the time of the Inspection. The Inspection and reporting is limited to a visual assessment of the Building Members in accord with Appendix C AS4349.1-2007.

The overall condition of this building has been compared to similar constructed buildings of approximately the same age where those buildings have had a maintenance program implemented to ensure that the building members are still fit for purpose.

The incidence of Major Defects in this Residential Building as compared with similar Buildings is considered: **Low**

The incidence of Minor Defects in this Residential Building as compared with similar Buildings is considered: **Medium**

The overall condition of this Residential Dwelling in the context of its age, type and general expectations of similar properties is: **Average**

Please Note: This is a general appraisal only, and cannot be relied upon on its own – read the Report in its entirety.

This Summary is supplied to allow a quick and superficial overview of the Inspection results. This Summary is NOT the Report and cannot be relied upon on its own. This Summary must be read in conjunction with the full Report and not in isolation from the Report. If there should happen to be any discrepancy between anything in the Report and anything in this Summary, the information in the Report shall override that in this Summary.

Property Statistics

Building Report	Average
Compliance Report	Please read full compliance report section of the report
Pest Inspection	Please read full pest inspection report
Energy Efficiency Rating	1.5 Stars
Inspection Date	Friday, 17 April 2015
Name of Assessor	Duncan Clark. Licence No - 2011260
Address of Property Inspected	68 Barada Crescent, Aranda ACT 2614
Surname of Property Owner	Galloway
Block and Section	Block 19 Section 28 Aranda
Year original residence was built	1970
Type of Building	Free standing residence
Bedrooms	4 Bedroom
Bathrooms	1 Main Bathroom + Ensuite
Block size (approximately)	1129m ²
House size	Upper Level Residence – 168.71m ² Lower Level Residence – 69.67m ² Total – 238.38m ²
Weather conditions at time of Inspection	Fine
Occupancy Status	Occupied

*The table above is to be used as a quick reference. Please read the full Report before reaching your conclusion regarding the condition of the Property.

Whilst every care has been taken to ensure the accuracy of the property house and block size, we accept no responsibility for any inaccuracies as supplying this information exceeds a standard building inspection under AS4349.1-2007.

Property Construction Details

Flooring	Timber bearer and joists to the main living areas. Concrete slab to the wet areas
External walls	Predominately brick veneer
Roof framing	Flat Roof construction
Roof cladding	Metal roofing
Fascia	Timber fascia boards
Gutters	Colorbond gutters
Fences	Timber fences
Window frames	Timber window frames and aluminium window frames
Glazing	Single glazed windows
Heating and cooling	Ducted gas heating
Cooktop	Freestanding electric cooktop and oven
Wall Insulation	Reflective foil installed
Ceiling Insulation	Thermal insulation value approximately R-2.0 with reflective foil

Whilst every care has been taken to ensure the accuracy of the property construction details, we accept no responsibility for any inaccuracies as supplying this information exceeds a standard building inspection under AS4349.1-2007.

General Access Limitations

Internal	At the time of inspection, the building was furnished. This allows for a limited inspection in areas not restricted by furnishings, stored goods, floor mats, etc.
External	Inspection was limited in areas around the fence line due to gardens restricting access.
Roof void	No inspection was made inside the roof void due to the flat roof construction.
Subfloor	The visual inspection of the subfloor framing was restricted due to sarking
On-top of roof	A full inspection was carried out on top of the roof
Garage	A full inspection was carried inside the garage

*Where access is noted as limited or restricted, it is recommended that access be gained to these areas as these areas may contain concealed defects.

Definitions

Good	The item is in the Inspector's opinion of an acceptable standard with no defects visible. Superficial defects will not be commented on.
Fair	The item in the Inspector's opinion has some minor defects and requires minimal maintenance or repair.
Poor	The item in the Inspector's opinion needs significant repair or replacement.

Entrance

Ceiling	Good
Walls	Good
Door and door hardware	Good
Floor coverings	Good – Timber floor installed
Windows	Good

Family Room

Ceiling	Good
Walls	Good
Floor coverings	The floor covering is showing signs of wear with repairs evident. Replacement of the vinyl flooring may be a consideration
Door and door hardware	Good
Windows	Good

Living Room

Ceiling	Good
Walls	Good
Door and door hardware	Good
Floor coverings	Good – Carpet installed as floor covering
Windows	A window is fixed in the closed position and could not be opened

Dining Room

Ceiling	Good
Walls	Good
Door and door hardware	Good
Floor coverings	Good – Timber floor installed
Windows	Good

Kitchen

Ceiling	Good
Walls	Good
Windows	Good
Kitchen cupboards	The cupboard under the sink is showing minor signs of water damage. At the time of inspection the cupboard was dry indicating that it is likely that the leak has been fixed. The cupboards are in fair/serviceable condition.
Bench top	Fair/Serviceable. There are some marks and signs of wear
Floor coverings	The floor covering is showing signs of wear with repairs evident. Replacement of the vinyl flooring may be a consideration
Splashback	The silicon joint between the bench top and the bottom of the splashback needs to be re-done. This is part of normal ongoing maintenance.
Is an exhaust fan fitted?	Yes - The exhaust fan was operational at the time of inspection.

Bedroom 1

Ceiling	Good
Walls	There is some patching to the render on the wall adjacent to the shower due to the previous water leak. No moisture was evident at the time of the inspection. Recommend monitoring of this area.
Door and door hardware	Good
Floor coverings	Good – Carpet installed as floor covering
Windows	There is a small crack in one pane of the secondary glazing. Repairs will be required in the future.
Wardrobe	Good

Bedroom 2

Ceiling	Good
Walls	Good
Door and door hardware	Good
Floor coverings	Good – Timber floor installed
Windows	Good

Bedroom 3

Ceiling	Good
Walls	Good
Door and door hardware	Good
Floor coverings	Good – Carpet installed as floor covering
Windows	Good
Wardrobe	Good

Bedroom 4

Ceiling	Good
Walls	Good
Door and door hardware	A small section of the door architrave and skirting board has been replaced. This is a cosmetic defect and no action is required.
Floor coverings	Good – Carpet installed as floor covering
Windows	Good
Wardrobe	Good

Bathroom

Ceiling	Good
Walls	Good
Door and door hardware	Good
Floor coverings	Good – Tiles installed as floor covering
Windows	Good
Shower screen	A shower curtain has been installed
Water leakage shower area?	There was no water leakage detected.
Floor and wall tiles in shower area	Good
Vanity/Basin	Good
Taps	Good
Bath	Fair - The bath has marks and signs of wear, however is still serviceable.

Ensuite

Ceiling	Good
Walls	Good
Door and door hardware	There are several marks to the door jamb and door architrave where sections of the architrave have been removed in the past. This is a cosmetic defect repairs are optional
Floor coverings	Good – Tiles installed as floor covering
Windows	Good
Shower screen	A shower curtain has been installed
Water leakage shower area?	There are signs that the shower has once leaked. It appears that repairs have been carried out. The shower was turned on for several minutes with no leaks evident. Apart from monitoring, no action is required.
Floor and wall tiles in shower area	Minor cracked tiles found in the shower base. Although this is unlikely to cause a leak it is advised to seal over the cracked tiles with a bathroom silicon. There are some missing tiles around the floor waste. Recommend a tiler rectify.
Vanity/Basin	Good
Taps	Good
Is an exhaust fan fitted?	Yes - The exhaust fan was operational at the time of inspection.
Toilet suite	The toilet cistern is not fully secured to the wall and was not functioning at the time of the inspection. Recommend a plumber carry out repairs.

Laundry

Ceiling	Good
Walls	Good
Door and door hardware	Good
Floor coverings	Good – Concrete floor
Windows	Good
Laundry tub	The laundry tub is showing signs of typical rust for a tub of this age. This tub is still considered to be in serviceable condition.

Toilet

Ceiling	Good
Walls	Good
Door and door hardware	Good
Floor coverings	Good – Tiles installed as floor covering
Windows	Good
Toilet suite	When the toilet was flushed, water was leaking from the toilet cistern. It is recommended to get a plumber to rectify.

Roof Cavity

Construction	Good
Ceiling Insulation	Thermal insulation value approximately R-2.0 with reflective foil

Workshop and Toilet

Ceiling	Good
Walls	Good
Windows	There was timber decay in a window frame. Repairs will be required in the future.
Toilet cistern	Fair - Single flush toilet

Subfloor

Was the ground dry?	The subfloor soil was generally dry at the time of inspection
Ventilation	Good
Floor structure	Good
Piers	Good
Access door to subfloor area	Good

Garage

Ceiling	Good
Slab	Good
Walls	Areas of cracking found in the external walls. This is likely to be caused by minor building settlement. The cracking found was not considered to be of major structural significance.
Garage door	Good

Exterior

Driveway and paths	Several areas of moderate cracking and movement found in the concrete paths. Recommend repairs to eliminate the trip hazard.
Roof covering	Good
Eaves	Areas of water staining found to the underside of the eave lining. This is likely to be caused by over flowing gutters during rain. Recommend clearing gutters from debris and monitoring during rainfall.
Fascia	Several end sections of the timber fascia are suffering from general weathering which is typical for a home of this age.
Gutters	Sections of the down pipes are leaking from the corners. Recommend repairs to these areas to prolong the life of the downpipes
External walls	Various areas of minor cracking found in the external walls. The cracking found was not considered to be of major structural significance.
External windows	The rubber seal at the bottom of various windows has deteriorated. Recommend re-sealing between the bottom of the window and the brick sill using an exterior flexible sealant like sikaflex.
Are garden beds and paths kept below damp proof course?	Yes
Fences	Fences are in a Fair/Serviceable condition
Gate	There is timber decay in the gate and repairs will be required in the future
Terrace handrails	There is minor timber decay in the handrails that will require repairs in the future
Pergola	Good
Brick walls	There is minor cracking to the brick walls. Recommend monitoring and if further movement occurs rectification will be required.
Site drainage	Good

Definitions

Above Average: The overall condition is above that consistent with dwellings of approximately the same age and construction. Most items and areas are well maintained and show a reasonable standard of workmanship when compared with buildings of similar age and construction.

Average: The overall condition is consistent with dwellings of approximately the same age and construction. There will be areas or items requiring some repair or maintenance.

Below Average: The Building and its parts show some significant defects and/or very poor non-tradesman like workmanship and/or long term neglect and/or defects requiring major repairs or reconstruction of major building elements.

Client The person or persons, for whom the Inspection Report was carried out or their Principal (i.e. the person or persons for whom the report is being obtained).

Building Consultant: A person, business or company who is qualified and experienced to undertake a pre-purchase inspection in accordance with Australian Standard AS 4349.1-2007 'Inspection of Buildings. Part 1: Pre-Purchase Inspections – Residential Buildings'. The consultant must also meet any Government licensing requirement, where applicable.

Building & Site: The inspection of the nominated residence together with relevant features including any car accommodation, detached laundry, ablution facilities and garden sheds, retaining walls more than 700 mm high, paths and driveways, steps, fencing, earth, embankments, surface water drainage and storm water run-off within 30 m of the building, but within the property boundaries. In the case of strata and company title properties, the inspection is limited to the interior and immediate exterior of the nominated residence and does not include inspection of common property.

Readily Accessible Areas: Areas which can be easily and safely inspected without injury to person or property, are up to 3.6 metres above ground or floor levels or accessible from a 3.6 metre ladder, in roof spaces where the minimum area of accessibility is not less than 600 mm high by 600 mm wide and subfloor spaces where the minimum area of accessibility is not less than 400 mm high by 600 mm wide, providing the spaces or areas permit entry. Or where these clearances are not available, areas within the consultant's unobstructed line of sight and within arm's length.

Structure: The loadbearing part of the building, comprising the Primary Elements.

Primary Elements: Those parts of the building providing the basic loadbearing capacity to the Structure, such as foundations, footings, floor framing, loadbearing walls, beams or columns. The term 'Primary Elements' also includes other structural building elements including: those that provide a level of personal protection such as handrails; floor-to-floor access such as stairways; and the structural flooring of the building such as floorboards.

Structural Damage: A significant impairment to the integrity of the whole or part of the Structure falling into one or more of the following categories:

- (a) Structural cracking and Movement – major (full depth) cracking forming in Primary Elements resulting from differential movement between or within the elements of construction, such as foundations, footings, floors, walls and roofs.
- (b) Deformation – an abnormal change of shape of Primary Elements resulting from the application of load(s).
- (c) Dampness – the presence of moisture within the building, which is causing consequential damage to Primary Elements.

- (d) Structural Timber Pest Damage – structural failure, i.e. an obvious weak spot, deformation or even collapse of timber Primary Elements resulting from attack by one or more of the following wood destroying agents: chemical delignification; fungal decay; wood borers; and termites.

“Conditions Conducive to Structural Damage” Noticeable building deficiencies or environmental factors that may contribute to the occurrence of Structural Damage.

Secondary Elements: Those parts of the building not providing loadbearing capacity to the Structure, or those non-essential elements which, in the main, perform a completion role around openings in Primary Elements and the building in general such as non-loadbearing walls, partitions, wall linings, ceilings, chimneys, flashings, windows, glazing or doors.

Finishing Elements: The fixtures, fittings and finishes applied or affixed to Primary Elements and Secondary Elements such as baths, water closets, vanity basins, kitchen cupboards, door furniture, window hardware, render, floor and wall tiles, trim or paint. The term ‘Finishing Elements’ does not include furniture or soft floor coverings such as carpet and lino.

Major Defect: A defect of significant magnitude where rectification has to be carried out in order to avoid unsafe conditions, loss of utility or further deterioration of the property.

Minor Defect: A defect other than a Major Defect.

Serious Safety Hazard: Any item that may constitute an immediate or imminent risk to life, health or property. Occupational, health and safety or any other consequence of these hazards has not been assessed.

Tests: Where appropriate the carrying out of tests using the following procedures and instruments:

- (a) Dampness Tests means additional attention to the visual examination was given to those accessible areas which the consultant’s experience has shown to be particularly susceptible to damp problems. Instrument testing using electronic moisture detecting meter of those areas and other visible accessible elements of construction showing evidence of dampness was performed.
- (b) Physical Tests means the following physical actions undertaken by the consultant: opening and shutting of doors, windows and draws; operation of taps; water testing of shower recesses; and the tapping of tiles and wall plaster.

Important Advice

NB. In the case of strata and company title properties, the Inspection is limited to the interior and immediate exterior of the particular unit being inspected. The exterior above ground floor level is not inspected. The complete Inspection of other common property areas would be the subject of a Special-Purpose Inspection Report which is adequately specified.

Trees: Where trees are too close to the house this could affect the performance of the footing as the moisture levels change in the ground. A Geotechnical Inspection can determine the foundation material and provide advice on the best course of action with regards to the trees.

The Septic Tanks: Should be inspected by a licensed plumber.

Swimming Pools: Swimming Pools/Spas are not part of the Standard Building Report under AS4349.1-2007 and are not covered by this Report. We strongly recommend a pool expert should be consulted to examine the pool and the pool equipment and plumbing, as well as the requirements to meet the standard for pool fencing. Failure to conduct this Inspection and put into place the necessary recommendations could result in finds for non-compliance under the legislation.

Surface Water Drainage: The retention of water from surface run off could have an effect on the foundation material which in turn could affect the footings to the house. Best practice is to monitor the flow of surface water and stormwater runoff and have the water directed away from the house or to storm water pipes by a licensed plumber/drainer.

Weep Holes: External brick (and stone) walls are a porous material that behave much like a sponge. During a rain event, the masonry wall absorbs water and actually stores it. The weep holes are designed for two purposes. 1. To provide an opening to allow water to drain out through the bottom of the wall. 2. To allow ventilating air to enter behind the wall to help dry the structure. If weep holes have been noted as being not installed, it is recommended to consult a builder on how to best rectify the problem.

Water Leaks from Roof: The inspector cannot, and does not, offer an opinion on whether the roof currently leaks or may be subject to future leaks. The only way to determine whether a roof is absolutely water tight is to make observations during prolonged heavy rainfall.

Subfloor dampness: The presence of dampness is not always consistent as the prevailing and recent weather conditions at the time an inspection is carried out may affect the detection of damp problems. The absence of any dampness at the time of inspection does not necessarily mean the building will not experience some damp problems in other weather conditions. Likewise whether or not services have been used for some time prior to an inspection being carried out will affect the detection of dampness.

Shower: Where a shower recess has been water tested, and no leakage was evident, this does not necessarily mean that the shower will not leak after prolonged use. Accordingly, to fully detect and assess a damp problem may require the monitoring of the building over a period of time.

Scope and Limitations

****Important Information Regarding the Scope and Limitations of the Inspection and this Report***

Any person who relies upon the contents of this Report does so acknowledging that the following clauses, which define the Scope and Limitations of the Inspection, form an integral part of the Report.

1) This Report is not an all-encompassing Report dealing with the building from every aspect. It is a reasonable attempt to identify any obvious or significant defects apparent at the time of the Inspection. Whether or not a defect is considered significant or not, depends to a large extent upon the age and type of the building inspected. This Report is not a Certificate of Compliance with the requirements of any Act, Regulation, Ordinance or By-law. It is not a structural Report. Should you require any advice of a structural nature you should contact a structural engineer.

2) This is a visual Inspection only, limited to those areas and sections of the property fully accessible and visible to the Inspector on the date of Inspection. The Inspection DID NOT include breaking apart, dismantling, removing or moving objects including, but not limited to, foliage, mouldings, roof insulation/sisalation, floor or wall coverings, sidings, ceilings, floors, furnishings, appliances or personal possessions. The inspector CANNOT see inside walls, between floors, inside skillion roofing, behind stored goods in cupboards and other areas that are concealed or obstructed. The inspector DID NOT dig, gouge, force or perform any other invasive procedures. Visible timbers CANNOT be destructively probed or hit without the written permission of the property owner.

3) This Report does not and cannot make comment upon: Defects that may have been concealed; the assessment or detection of defects (including rising damp and leaks) which may be subject to the prevailing weather conditions; whether or not services have been used for some time prior to the Inspection and whether this will affect the detection of leaks or other defects (*e.g. In the case of shower enclosures the absence of any dampness at the time of the inspection does not necessarily mean that the enclosure will not leak*); the presence or absence of timber pests; gas-fittings; common property areas; environmental concerns; the proximity of the property to flight paths, railways, or busy traffic; noise levels; health and safety issues; heritage concerns; security concerns; fire protection; site drainage (apart from surface water drainage); swimming pools and spas (non-structural); detection and identification of illegal building work; detection and identification of illegal plumbing work; durability of exposed finishes; neighbourhood problems; document analysis; electrical installation; any matters that are solely regulated by statute; any area(s) or item(s) that could not be inspected by the consultant.

Accordingly, this Report is NOT a guarantee that defects and/or damage does not exist in any inaccessible or partly inaccessible areas or sections of the property.

NB. Such matters may, upon request, be covered under the terms of a 'Special-Purpose Property Report'.

4) Consumer Complaints Procedure: In the event of any dispute or claim arising out of, or relating to the Inspection or the Report, you must notify us as soon as possible of the dispute or claim by email, fax or mail. You must allow us (which includes persons nominated by us) to visit the property (which visit must occur within twenty eight (28) days of your notification to us) and give us full access in

Property: 68 Barada Crescent, Aranda ACT 2614

order that we may fully investigate the complaint. You will be provided with a written response to your dispute or claim within twenty eight (28) days of the date of the Inspection.

If you are not satisfied with our response, you must within twenty one (21) days of your receipt of our written response, refer the matter to a Mediator nominated by us from the Institute of Arbitrators and Mediators of Australia. The cost of the Mediator will be borne equally by both parties, or as agreed as part of the mediated settlement.

Should the dispute or claim not be resolved by mediation, then the dispute or claim will proceed to arbitration. The Institute of Arbitrators and Mediators of Australia will appoint an Arbitrator who will hear and resolve the dispute. The arbitration, subject to any directions of Arbitrator, will proceed in the following manner:

(a) The parties must submit all written submissions and evidence to the Arbitrator within twenty one (21) days of the appointment of the Arbitrator; and

(b) The arbitration will be held within twenty one (21) days of the Arbitrator receiving the written submissions.

The Arbitrator will make a decision determining the dispute or claim within twenty one (21) of the final day of the arbitration. The Arbitrator may, as part of his determination, determine what costs, if any, each of the parties are to pay and the time by which the parties must be paid any settlement or costs.

The decision of the Arbitrator is final and binding on both parties. Should the Arbitrator order either party to pay any settlement amount or costs to the other party but not specify a time for payment, then such payment shall be made within twenty one (21) days of the order.

NB. In the event that you do not comply with the above Complaints Procedure and commence litigation against us, then you agree to fully indemnify us against any awards, costs, legal fees and expenses incurred by us in having your litigation set aside, or adjourned to permit the foregoing Complaints Procedure to complete.

5) Asbestos Disclaimer: “No Inspection for Asbestos was carried out at the property, and no Report on the presence or absence of Asbestos is provided”.

If during the course of the Inspection, asbestos or materials containing asbestos happened to be noticed, then this may be noted in the ‘Additional Comments’ section of the Report. Buildings built prior to 1982 may have wall and/or ceiling sheeting, and other products including roof sheeting that contains Asbestos. Even buildings built after this date, up until the early 90s, may contain some Asbestos. Sheeting should be fully sealed. If you are concerned, the building was built prior to 1990, or if asbestos is noted as present within the property, then you should seek advice from a qualified asbestos removal expert as to the amount and importance of the asbestos present and the cost of sealing or removal. Drilling, cutting or removing sheeting or products containing Asbestos is a high risk to peoples’ health. You should seek advice from a qualified asbestos removal expert.

Property: 68 Barada Crescent, Aranda ACT 2614

6) Mould (Mildew and non-wood decay fungi) Disclaimer: Mildew and non-wood decay fungi are commonly known as mould. However, mould and their spores may cause health problems or allergic reactions, such as asthma and dermatitis in some people. No Inspection for mould was carried out at the property, and no Report on the presence or absence of mould is provided. If in the course of the Inspection, mould happened to be noticed, it may be noted in the 'Additional Comments' section of the Report. If mould is noted as present within the property, or if you notice mould and you are concerned as to the possible health risk resulting from its presence, then you should seek advice from your local Council, State or Commonwealth Government Health Department, or a qualified expert such as an Industry Hygienist.

7) Magnesite Flooring Disclaimer: No Inspection for Magnesite Flooring was carried out at the property, and no Report on the presence or absence of Magnesite Flooring is provided. You should ask the owner whether Magnesite Flooring is present and/or seek advice from a Structural Engineer.

8) Estimating Disclaimer: Any estimates provided in this Report are merely opinions of possible costs that could be encountered, based on the knowledge and experience of the inspector, and are not estimates in the sense of being a calculation of the likely costs to be incurred. The estimates are NOT a guarantee or quotation for work to be carried out. The actual cost is ultimately dependent upon the materials used, standard of work carried out, and what a contractor is prepared to do the work for. It is recommended in ALL instances that multiple independent quotes are sourced prior to any work being carried out. The inspector accepts no liability for any estimates provided throughout this Report.

9) Note: If the Client has any doubt about the purpose, scope and acceptance criteria on which the Report was based please discuss your concerns with the Consultant on receipt of the Report. The Client acknowledges that, unless stated otherwise, the Client as a matter of urgency should implement any recommendation or advice given in this Report.

Important Disclaimer

Disclaimer Liability: No Liability shall be accepted on an account of failure of the Report to notify any problems in the area(s) or section(s) of the subject property physically inaccessible for Inspection, or to which access for Inspection is denied by or to the Inspector (including but not limited to or any area(s) or section(s) so specified by the Report).

Disclaimer of Liability to Third Parties: Compensation will only be payable for losses arising in contract or tort sustained by the Client named on the front of this Report. Any third party acting or relying on this Report, in whole or in part, does so entirely at their own risk. However, if ordered by a Real Estate Agent or a Vendor for the purpose of auctioning a property, then the Inspection Report may be ordered up to seven (7) days prior to the auction, copies may be given out prior to the auction and the Report will have a life of 14 days during which time it may be transferred to the purchaser. Providing the purchaser agrees to the terms of this agreement, then they may rely on the Report subject to the terms and conditions of this agreement and the Report itself.

NB. In the ACT under the Civil Law (Sale of Residential Property) Act 2003 and Regulations, the Report resulting from this Inspection may be passed to the purchaser as part of the sale process, providing it is carried out no more than three months prior to listing and is not more than six months old.

Limited Liability to a Purchaser within the Australian Capital Territory only: Within the Australian Capital Territory (ACT) and in accordance with the ACT Civil Law (Sale of Residential Property) Act 2003 and Regulations, a copy of the Report may be attached to the Contract for Sale.

This Report may be attached to the Contract provided that:

I. This Report must include: -

(a) The Inspection Date; and

(b) The Pacific International Insurance Limited policy number and expiry date of the professional indemnity insurance policy covering the Inspector who provided the Report.

II. The Vendor and the Purchaser are advised that within 7 days (7) after the Inspection Date, the following information will be given to the Territory (defined in the Act) for inclusion in a publicly available register: -

(a) The fact that this Report has been prepared; and

(b) The street address of the property Inspected; and

(c) The Inspection Date stated in this Report; and

(d) The name and contact details of the company, partnership or sole trader that employs the Timber Pest Inspector who prepared the Report; and

(e) The name of the Timber Pest Inspector who carried out the Inspection.

Property: 68 Barada Crescent, Aranda ACT 2614

III. As required by Part 2, Section 7 and Clause 5 of the Regulations, the circumstances in which reliance may be placed on the Report in respect to the State of the property at the time of the Inspection are;

(a) The Inspection was carried out no more than three months prior to the date the property named on the front of the Report was first listed or offered for sale; and

(b) The date on which the settlement took place was not more than one hundred and eighty (180) days after the Inspection Date; and

(c) The Report is given by the Vendor to the prospective Purchaser prior to Exchange and prior to the expiration of any 'Cooling-off Period' allowed in the Act; and

(d) The Purchaser completes, signs and dates the "Notice to the Purchaser" before settlement; and

(e) The Purchaser transmits by fax, post or otherwise delivers the signed "Notice to the Purchaser" to the company, partnership or sole trader at the address shown on the front of the Report not less than four (4) days prior to the date of settlement.

NB. No reliance may be placed on the Report for any contract entered into more than six months after the date of Inspection.

IV. The Vendor and the Purchaser are advised that, upon payment of a reasonable fee, the company, partnership or sole trader that employed the Timber Pest Inspector who prepared this Report may supply a copy to any person, Solicitor, company or organisation purporting to represent or be a person who has entered into a contract to buy the property.

NB. The provisions of the above 'Limited Liability to a Purchaser within the Australian Capital Territory only' clause together with the 'Notice to the Purchaser' shall, in all circumstances, form part of the Contract between the Purchaser and the company, partnership or sole trader that employs the Inspector who carried out the Inspection.

WARNING: The Purchaser is advised that this Report reflects the condition of the property existing at the time of the Inspection (Inspection Date) and may not reflect the current state. It is, therefore, **very strongly recommended** that you promptly arrange for another Inspection and Report in accordance with Australian Standard AS4349.1 to be carried out prior to the expiration of the 'Cooling off Period' and settlement.

This is not a Compliance Report strictly in accordance with Civil Law (Sale of Residential Property)

Regulations: The Report may contain copies of any approved plans, building approvals, building permit and Certificates of Occupancy. However, any comments made by the person who prepared the Report as to whether or not, in the opinion of the Inspector, the structures on the land substantially comply with the approved plans (if any) are made on the basis of a cursory glance of the plans and not upon a detailed examination. Any opinion expressed as to whether or not any building approval or approval under the Land (Planning and Environment) Act, 1991, is based on the limited knowledge and belief, at the time, of the Inspector. The Purchaser is advised that a Special Purpose Report is available through the Inspector to advise more fully in respect to these matters. The structures may have been damaged by pests, storm, strong wind or fire or the Vendor may have

Property: 68 Barada Crescent, Aranda ACT 2614

carried out alterations and/or additions to the Property since the Inspection Date. The Report may no longer reflect the true condition of the Property. The structure(s) may no longer be in accordance with the attached plans etc. IT IS STRONGLY RECOMMENDED that, if the Purchaser has any concerns in respect to the compliance of the structures, a Special Purpose Report be obtained. Alternatively, the Purchaser should rely upon his, her or their own enquiries.

Contact the Inspector: Please feel free to contact the Inspector who carried out this Inspection. Often it is very difficult to fully explain situations, problems, access difficulties, building faults or their importance in a manner that is readily understandable by the reader. Should you have any difficulty in understanding anything contained within this Report, then you should immediately contact the Inspector and have the matter explained to you. If you have any questions at all, or require any clarification, then contact the Inspector prior to acting on this Report.

The Inspection and Report was carried out by: Robert Lowe 0415775477

Other Inspections and Reports Required

It is strongly recommended that the following Inspections and Reports be obtained prior to any decision to purchase the Property. Obtaining these Reports will better equip the purchaser to make an informed decision. Although appliances may be listed in the Report, they have not been tested as this is outside the scope of the standard Building Inspection. Other Inspections we recommend the purchaser obtains before making their decision are;

- Electrical Inspection,
- Plumbing Inspection,
- Structural (Engineer)
- Geotechnical Inspection,
- Drainage Inspection,
- Asbestos Inspection,
- Mould Inspection,
- Gas fitting Inspection,
- Appliances Inspection,
- Air-conditioning Inspection,
- Alarm/Intercom/Data Systems,
- Hydraulics Inspection,
- Mechanical Services,
- Hazards Inspection,
- Fire/Chimney Inspection,
- Estimating Report,
- Garage Door Mechanical,
- and Durability of Exposed Surfaces

Smoke Detectors

The purchaser should satisfy themselves as to the working condition of the smoke detectors, if installed. It is highly recommended that suitable smoke detectors be installed in all residential properties. AS 3786 advises that smoke detectors are required for all buildings where people sleep. It is recommended that an electrician be consulted to advise on those installed or install these detectors.

Cracking of Building Items

Definitions:

Appearance Defect- Where in the inspector's opinion the appearance of the building item has deteriorated at the time of the Inspection and the significance of this cracking is unknown until further information is obtained.

Serviceability Defect- Where in the inspector's opinion the performance of the building item is flawed at the time of the Inspection and the expected significance of this cracking is unknown until further information is obtained.

Structural Defect - Where in the inspector's opinion the structural soundness of the building item has diminished at the time of the Inspection and the expected significance of this cracking is unknown until further information is obtained.

Important:

Regardless of the type of crack(s) a Pre Purchase Building Inspector carrying out a Pre Purchase Inspection within the scope of a visual Inspection is unable to determine the expected consequences of the cracks.

Obtaining Information regarding:

- (a) The nature of the foundation material on which the building is resting,
- (b) The design of the footings,
- (c) The site landscape,
- (d) The history of the cracks and,
- (e) Carrying out an invasive Inspection.

All fall outside the scope of this Pre Purchase Inspection. However, the information obtained from the five items above is valuable in determining the expected consequences of the cracking and any remedial work needed.

Cracks that are small in width and length on the day of the Inspection, may have the potential to develop over time into structural problems for the home owner, resulting in major expensive rectification work been carried out.

If cracks have been identified in the Report above, then a **Structural Engineer** is required to determine the significance of the cracking prior to a decision to purchase.

Notice to the Purchaser (ACT only)

(a) At the Exchange, and prior to the 'Cooling-off Period', you were given an Inspection Report on the property you intend on purchasing. This Report reflects the condition of the property existing at the time of the Inspection (Inspection Date), and may not reflect the current state. The structures may have been damaged by pests, storm, strong wind or fire or the vendor may have carried out alterations and/or additions to the property since the Inspection date. The Report may no longer reflect the true condition of the property. The structure(s) may no longer be in accordance with the attached plans etc. It is, therefore, **very strongly recommended** that you urgently arrange for another Inspection and Report in accordance with Australian Standard AS 4349.1 to be carried out prior to exchange, or prior to the expiration of any 'Cooling Off Period' and prior to settlement.

(b) If the Report indicated the presence of termite damage, or recommends any other Inspections or treatments, you should obtain copies of these Reports and any treatment proposals, certificates of treatment carried out, including details of all repairs including copies of quotations, invoices and any other Reports. It is **strongly recommended** that you arrange for an Inspection and Report in accordance with AS 4349.3 to verify that the treatment has been successful and carried out in accordance with AS 3660.2, and a further building Inspection in accordance with AS 4349.1.

(c) If you fail to procure a further Inspection and Report as recommended in (a) and (b), or fail to obtain copies of other Reports, treatment proposals, certificates of treatment carried out, details of all repairs including copies of quotations, invoices and any other Reports as recommended in (b) above, then you agree that you have decided not to have a further Inspection and Report carried out, or to obtain copies of treatment proposals, certificates of treatment carried out, details of all repairs including copies of quotations, invoices and any other Reports and have relied upon your own enquires and the Report, knowing the possible consequences, and that the condition of the property, as stated in the Report, may have changed.

(d) You agree that the person carrying out the Inspection and the company, partnership or sole trader that employs that person will have no liability to you for any damage or loss you may suffer as a result of your entering the contract to purchase the property, or in connection with completing the purchase of the property as a result of your failure to heed the advice given in (a) and (b) and the warning contained in (c) above, and may use such failure in defence of any claim that you may later make against any of them.

NB. It is a condition of your right to rely upon the Report that you transmit by fax, post or otherwise deliver the signed "Notice to the Purchaser" (ACT only) to the company, partnership or sole trader at the address detailed on the front of the Report not less than four (4) days prior to the date of settlement. If you fail to complete, sign or deliver the Notice then it will be deemed that you did not rely upon the report in respect to your decision as to whether or not to purchase the property. This may seriously affect any rights to future compensation to which you may be entitled.

Property: 68 Barada Crescent, Aranda ACT 2614

Please cross out the statement below that does not apply: - At the date of settlement, not more than 180 days will have elapsed since the Inspection date;

1. I/We have read and understood the 'Limited Liability to a Purchaser within the Australian Capital Territory only' clause of the Report, and this Notice to the Purchaser. I/We have not arranged for another inspection and report in respect of the property and it is my/our intention to **rely upon the findings contained in the report**; or

2. I/We have **arranged for another Inspection of the Property and Report** to be carried out, which I/We will use in conjunction with this Report in deciding whether to proceed with the purchase of the property; or

3. I/We have read and understood the 'Limited Liability to a Purchaser within the Australian Capital Territory only' clause of the Report, and this Notice to the Purchaser. I/We have not arranged for another Inspection and Report in respect of the property and have **relied on my/our own enquiries in respect of the condition of the property** as at the date of settlement including any changes in the condition of the property that have taken place since the Inspection date stated in the Report.

Compliance Report

This is a Compliance Report with regard to any unapproved structures or alterations. ACT Property Inspections have accessed the attached Building File from ACT Planning and Land Authority (ACTPLA) and hold no responsibility for any inaccuracies in the Building File supplied by ACTPLA. The Compliance report is based solely upon the information available from the Building File which does not contain information in regards to Plumbing or Electrical work that has taken place since the original construction. Information in regards to the Plumbing and Electrical is available upon application from ACTPLA. Since we are not Plumbers or Electricians, we are unable to comment on those works. If structures have been noted as requiring approval, a Certifier should be engaged to assess if the structure will comply with the relevant ACT legislation. Owners must be aware that unapproved structures may not comply and may require significant repair, design change or possible removal.

Address	68 Barada Crescent, Aranda ACT 2614
Block and Section	Block 19 Section 28 Aranda
Date of Inspection	Friday, 17 April 2015

Approval Status

Description	Plan number	Certificate of occupancy date	Approval status
Residence	17307+A+B+C	27/10/1970	Approved
Step Replacing Ramp	17307/D	-	This structure is exempt from approval. No action is required.
Pergola to terrace	-	-	This structure is unapproved and requires design and approval.

ACTPLA Comments

- Plan 17307/D details (step replacing ramp). At that time didn't require COU. See attached letter.

Survey Report

Survey Report completed by	Date Survey report was completed	Comments
Courtenay & Barrett Land & Engineering Surveyors	Thursday, 11 September 1969	There are no apparent encroachments upon this land or by this property on adjoining lands or street.

17307



Building Conveyancing Enquiries and Energy Rating Package Application

About this form

Use this form to request and pay for an Energy Rating Package or Conveyancing Enquiry for either a Residential or Non Residential ACT property with the Environment and Planning Directorate.

All fields are mandatory unless stated otherwise.



Maximum \$10,000

The ACT Government is committed to improving the accessibility of web content. To provide feedback or request an accessible version of a document please phone 13 22 81.

Request Type & Professional User

Select a request type

Residential conveyancing enquiry

Are you a Professional User registered with the Environment and Planning Directorate?

Yes No



Professional User Details

Professional User ID

6886937

Name title (optional)

Mr

Given name

Robert

Family name

Lowe

Contact phone number

0262922278

Property Information

Suburb/District

ARANDA

Section

28

Block

19

Unit (optional)

Lessee

R. Galloway

Applicant's Reference (optional)

If you require help with suburb/district, section or block details click this information button



Address

68 Barada Crescent, Aranda ACT 2614

Address (optional)

Suburb

ARANDA

State/Territory

ACT

Postcode

2614

Location description (optional)

Additional Property Information

If the residence is a former Government residence without alterations or additions, the building plans may not be available.

Is the property an ex Government residence? Yes No

Additional Documentation

Please click the appropriate box to include any of the following documentation. Additional fees apply (optional)

Sanitary Drainage Plan

Priority

Our aim is to provide a 4 to 5 full working day turnaround period for a standard service. The turnaround time commences from receipt of the request at Mitchell and does not include weekends, public holidays or delivery time by mail or DX for professional users. For high priority requests an additional surcharge is applied and the turnaround period is 24 hours with the same conditions specified above.

What is the priority of this request? Standard High

Method of Delivery

Please select your preferred delivery method

- Collect at Mitchell Counter
- Collect at ACT Government Shopfront
- DX number
- By mail to the address provided

Applicant Declaration

As the applicant lodging this request, you are declaring:

- I am the lessee/owner.
- I am the solicitor acting on behalf of the lessee/owner.
- I have authorisation from the lessee/owner.
- I am/act for a mortgagee in possession.
- I have authorisation from the solicitor representing the lessee/owner.
- I have authorisation from the Trustee of the deceased estate.
- I have authorisation for power of attorney from the lessee/owner.

Please Note:

1. Documentation confirming that you have the lessee/owner's permission is required in all instances. Unless you have a "Professional User" ID you must present this written proof when you collect the requested information from the Mitchell Counter.
2. The applicant must comply with one of the above declarations to protect any personal information relating to the lessee/owner of this lease under the provisions of the Privacy Act 1988.
3. Section 59A of The Building Act 2004 provides severe penalties for false or misleading statements.

Pay Now

Payment amount

\$ 108.20

Receipt

Your payment has been successful. Please keep a copy of this receipt for your records.

Date and time **09 Apr 2015 10:10:50**

Form submission ID **34003920150409106906**

Payment receipt number **1514256943**

Total amount paid \$ **108.20**

To save or print a copy of the completed form and receipt go to the "File" menu and select "Save as" or "Print".

Environment and
Planning Directorate
ABN 31 432 729 493

GPO Box 1908
Canberra ACT 2601
Telephone: 132281

[EPD Information Privacy Policy](#)

Form ID: 1014

Version: 25

Date: 09 Apr 2015

CONVEYANCING BUILDING FILE INDEX

SUBURB: **Aranda** SECTION: **28** BLOCK: **19** UNIT: **-** EX GOV: **No** PAGE: **1/1**

COU ISSUED Y/N	PLAN NUMBER	FOLIO NO.	DESCRIPTION OF WORK	AMEND	DETAILS	INDEM INSUR	SURVEY	PERMIT NUMBER	COST OF WORKS	COU PLAN NO. & DATE	FOOTINGS DATE
Y	17307	5	Residence						\$22,248		
Y	17307/A	7		Y							
		11						17307			
Y	17307/B	14		Y							
Y	17307/C	22		Y							
		33-34	Survey				Y				
		34	Survey				Y				
		39	Final (17307+A+B+C)								07-09-70
		44								17307+A+B++C 27-10-70	
N/A	17307/D	46	Step Replacing ramp		Y						

Drainage Plan Number: 14001

Soil Classification Number: No

Comments: Plan 17307/D details (Step Replacing ramp). At that time didn't require COU. See attached Letter.

CONVEYANCING PART 2

No information is provided in respect of electrical, drainage or sewer matters and or to the location of overhead power lines or underground cables in relation to the building.

- | | <u>Yes</u> | <u>No</u> |
|---|--------------------------|-------------------------------------|
| 1. (a) Is this a government or ex government house? | <input type="checkbox"/> | <input checked="" type="checkbox"/> |
| (b) If yes, is there a building file with approvals on it? | <input type="checkbox"/> | <input type="checkbox"/> |
| 2. Is there any record of incomplete building work on the building file?
If yes - file copies attached | <input type="checkbox"/> | <input checked="" type="checkbox"/> |
| 3. Are there any records on the building file of current (within 5 years) housing Indemnity insurance policies for building work? If yes - file copies attached | <input type="checkbox"/> | <input checked="" type="checkbox"/> |
| 4. Are there any records on the building file showing building applications still being processed? (Current within 3 years) If yes - file copies attached | <input type="checkbox"/> | <input checked="" type="checkbox"/> |
| 5. Are there any records on the building file in relation to loose-fill asbestos insulation? | <input type="checkbox"/> | <input checked="" type="checkbox"/> |

If available, copies of the following documents are provided:

- | | | |
|--|-------------------------------------|-------------------------------------|
| • Certificate/s of Occupancy and Use | <input checked="" type="checkbox"/> | <input type="checkbox"/> |
| • Survey Certificates | <input checked="" type="checkbox"/> | <input type="checkbox"/> |
| • Approved Building Plans | <input checked="" type="checkbox"/> | <input type="checkbox"/> |
| • Ex- government Building Plans | <input type="checkbox"/> | <input checked="" type="checkbox"/> |
| • Certificate of Completion of Asbestos Removal work** | <input type="checkbox"/> | <input checked="" type="checkbox"/> |

** If YES – this indicates that the property was part of the Loose Asbestos Insulation Program.
For more information go to the Asbestos Awareness Website – www.asbestos.act.gov.au

If requested:

- | | | |
|--------------------|-------------------------------------|--------------------------|
| • Drainage Plan(s) | <input checked="" type="checkbox"/> | <input type="checkbox"/> |
|--------------------|-------------------------------------|--------------------------|

ASBESTOS

**The ACT Government is not able to guarantee the accuracy of the information in this report.

You should make your own enquiries and obtain reports (from a licensed Asbestos Assessor) in relation to the presence of loose fill asbestos insulation (and other forms of asbestos) on the premises. For more information go to the Asbestos Awareness Website – www.asbestos.act.gov.au

Please Note: Building approvals that have been generated via eDevelopment will be issued with a project number prefixed by the letter B. Initial building approval documentation will be identified with project number B20XXXX only but will be referenced as B20XXXX/A on the Certificate of Occupancy and Use. Any amendments to the original approval will be issued with the project number and an alphanumeric digit. The first amendment will be identified as B20XXXX/B, the second amendment B20XXXX/C etc.

Search officer comments (if any?)

Search officer initials: Dhruba

Cost of application: \$ 108.20

Date completed:

14-04-15

17307 PA

COURTENAY & BARRETT
LAND & ENGINEERING SURVEYORS

Registered under Surveyor's Act, 1929
Licensed to practice in the A.C.T.

Office Address
ROOM 2, MANUKA ARCADE
MANUKA, A.C.T. 2603
Phone 9 4633



BEDE S. COURTENAY
20 Rodway Street, Yarralumla
Phone 81 2511

PETER G. BARRETT
42 Cadell Street, Downer
Phone 48 9417

Ref. 36/69.70

11th September, 1969.

Survey Report Re BLOCK 19, SECTION 28, DIVISION of ARANDA.

As instructed I have surveyed all that piece or parcel of land, containing 1 rood, 4 $\frac{1}{2}$ perches, being BLOCK 19, SECTION 28, DIVISION of ARANDA, CANBERRA CITY DISTRICT, AUSTRALIAN CAPITAL TERRITORY.

I hereby certify that erected wholly upon the above-mentioned land, in the position shown on the accompanying sketch, is a Brick House, under construction.

There are no encroachments on this property and none by this property upon any adjoining lands or Crescent.

P. G. Barrett
REGISTERED SURVEYOR.



SKETCH

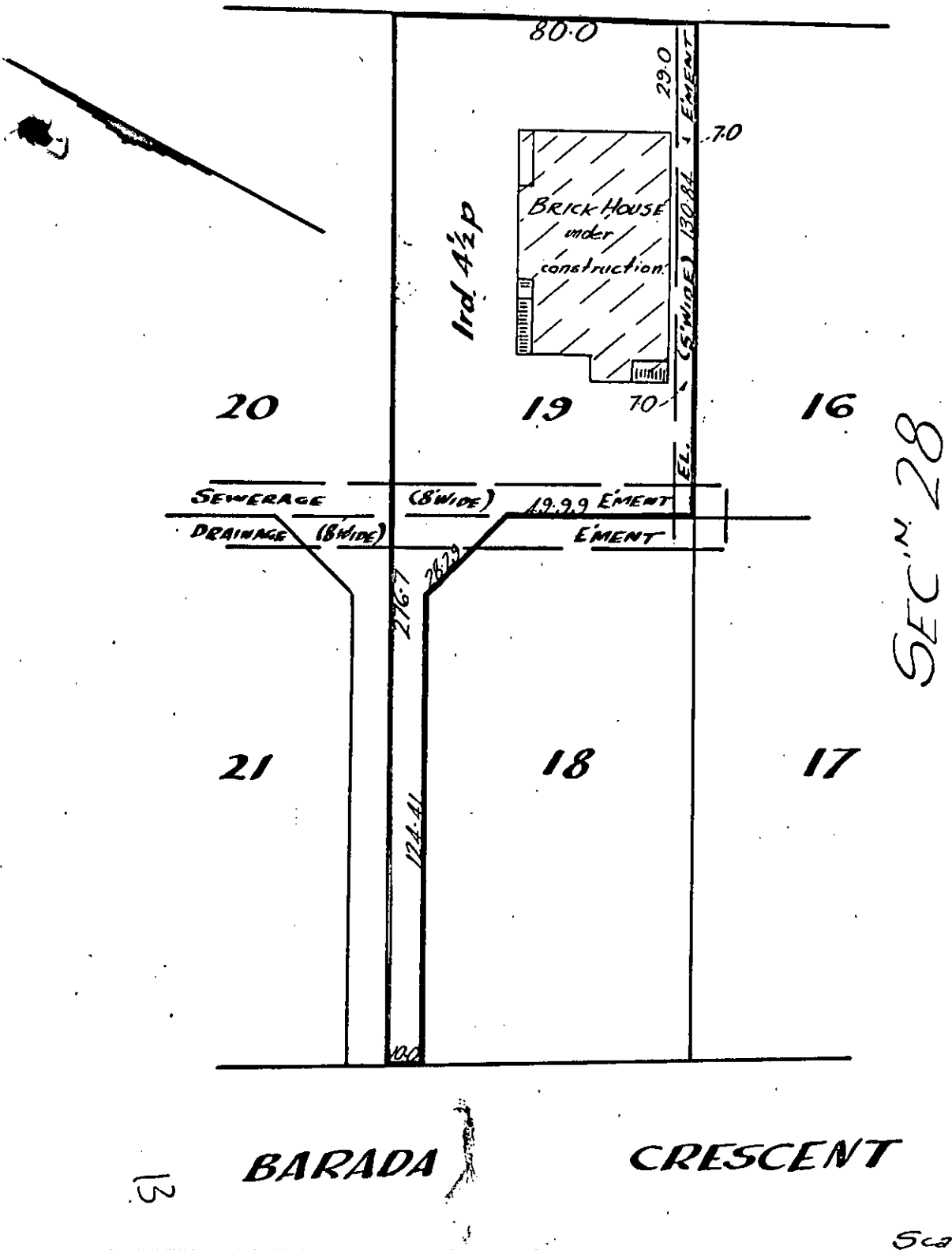

80.0

29.0

70

1rd. A 1/2 p

BRICK HOUSE
under
construction.

20

19

70

16

SEWERAGE (8" WIDE)

19.99 EMENT

DRAINAGE (8" WIDE)

EMENT

216.7

26.73

21

18

17

124.41

100

SEC. N. 28

BARADA

CRESCENT

13

Scale: 40' = 1"

17307 PA 31/8

37

COURTENAY & BARRETT

LAND & ENGINEERING SURVEYORS

Registered under Surveyor's Act, 1929
Licensed to practice in the A.C.T.

Office Address

ROOM 2, MANUKA ARCADE
MANUKA, A.C.T. 2603
Phone 9 4633

BEDE S. COURTENAY

20 Rodway Street, Yarralumla
Phone 81 2511

PETER G. BARRETT

42 Cadell Street, Downer
Phone 48 9417

Ref..... 36/69.70.....

11th September, 1969.

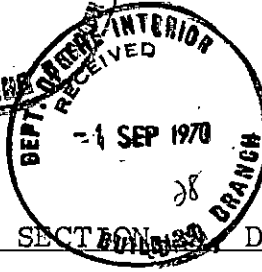
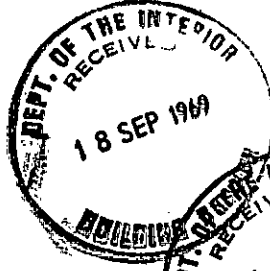

Survey Report Re BLOCK 19, SECTION 28, DIVISION of ARANDA.

As instructed I have surveyed all that piece or parcel of land, containing 1 rood, 4 1/2 perches, being BLOCK 19, SECTION 28, DIVISION of ARANDA, CANBERRA CITY DISTRICT, AUSTRALIAN CAPITAL TERRITORY.

I hereby certify that erected wholly upon the above-mentioned land, in the position shown on the accompanying sketch, is a Brick House, under construction.

There are no encroachments on this property and none by this property upon any adjoining lands or Crescent.

Brick screen wall added to report 1/9/70.

P. G. Barrett

P. G. Barrett
REGISTERED SURVEYOR.

SKETCH

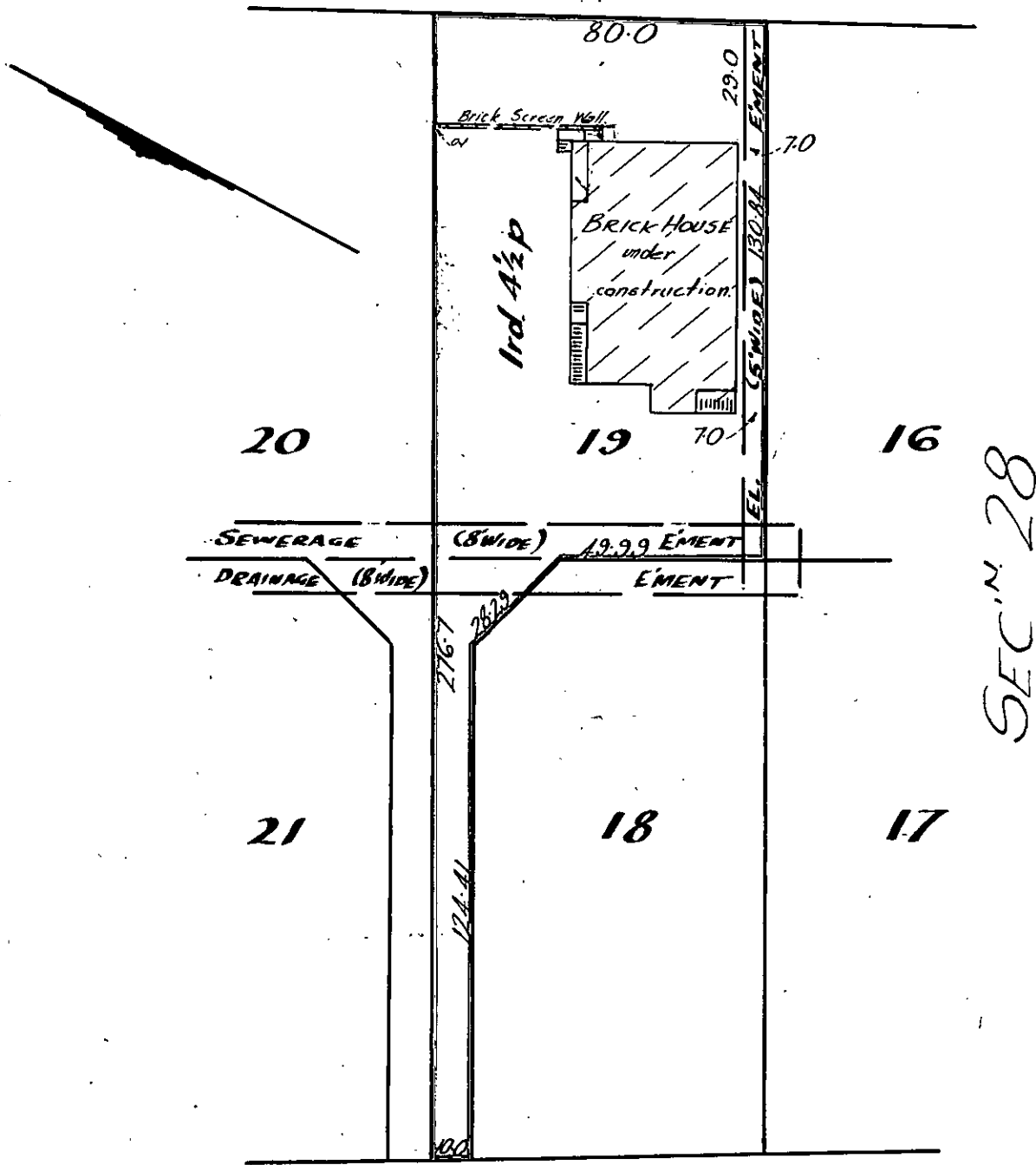

SEC. 28

BARADA

CRESCENT

13

CERTIFICATE AS TO FITNESS FOR OCCUPANCY AND USE

Plan Number(s) 17307 17307/A/B/C	Permit Holder H. LINDKVIST
	Lessee R.W. & N.G. GALLOWAY

I certify that a

BRICK RESIDENCE

on Block 19 of Section 28 at ARANDA

is fit for occupancy and use.

27 OCT 1970

Deputy Proper Authority

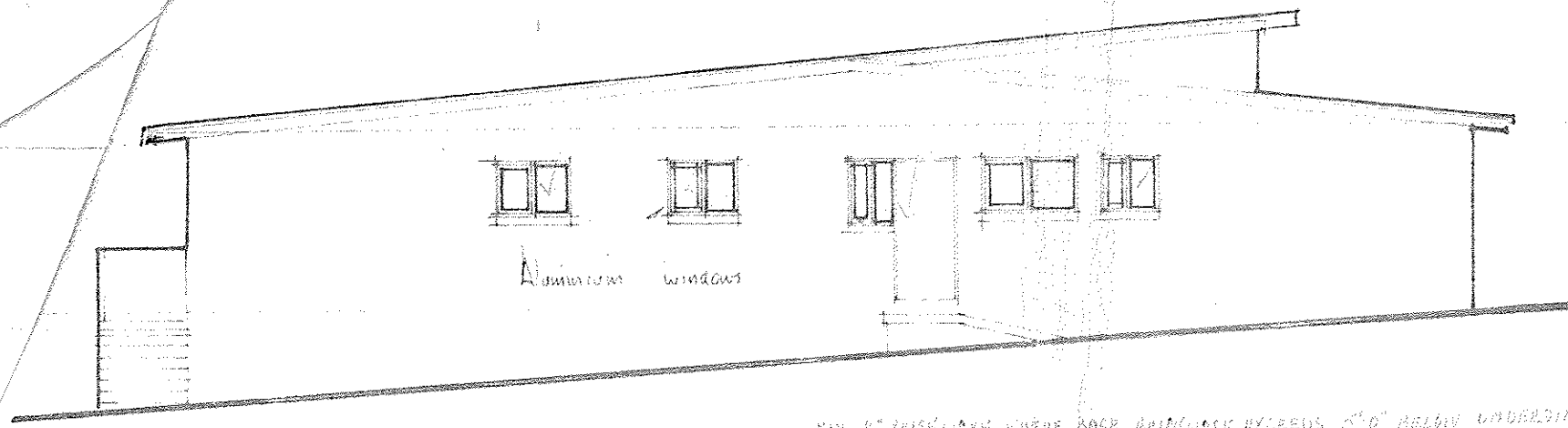

SOUTH ELEVATION

PRELIMINARY LONGITUDINAL SECTION
IN LINE BB ON PLAN

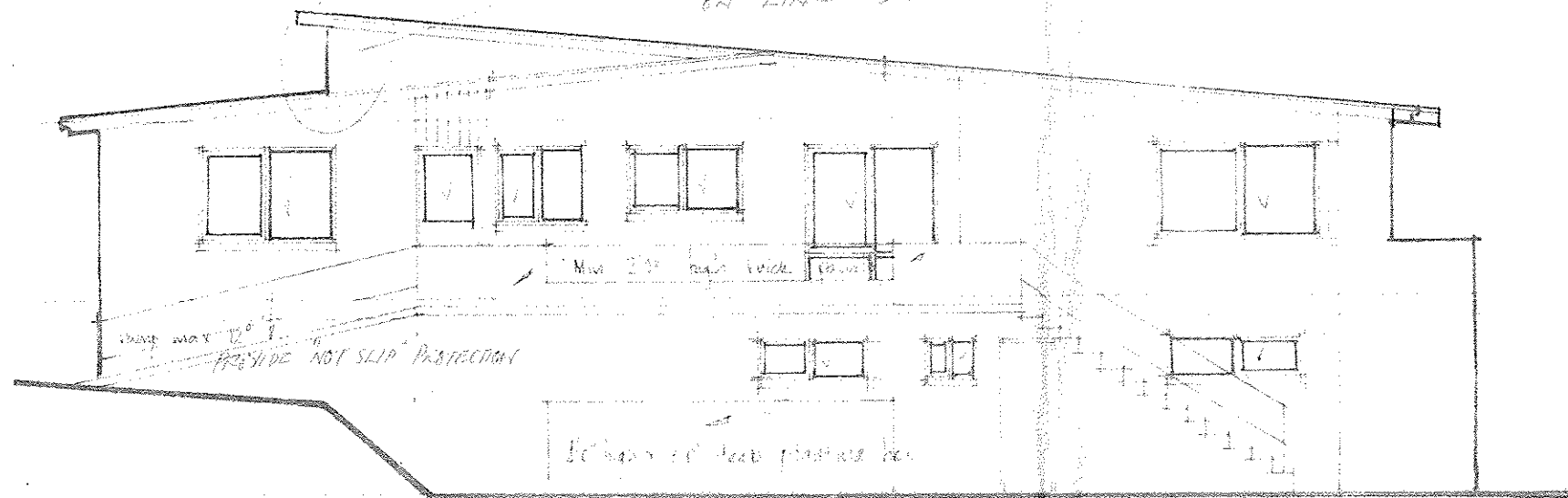

NORTH ELEVATION

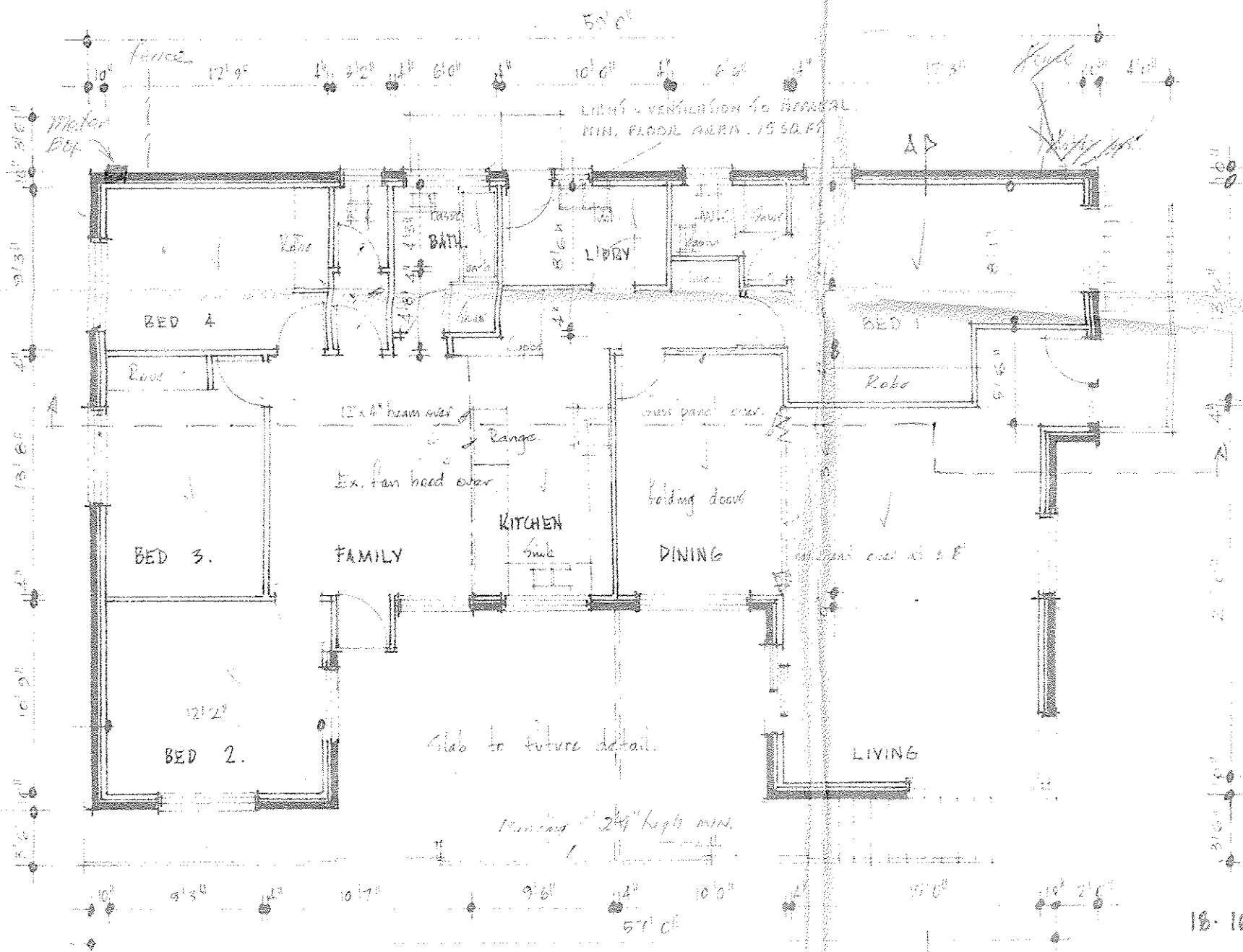

DIMENSIONS TO BE CHECKED BY CONTRACTOR.

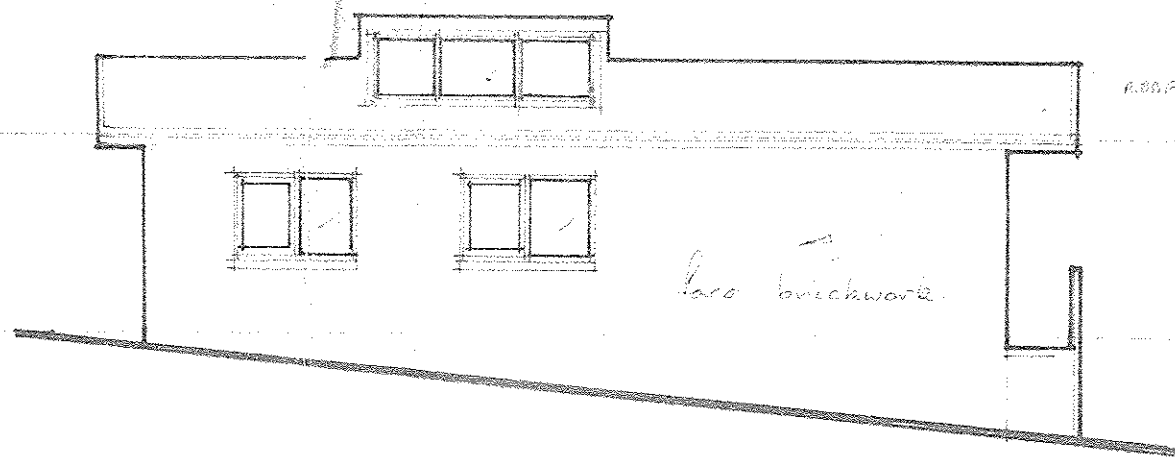

EAST ELEVATION

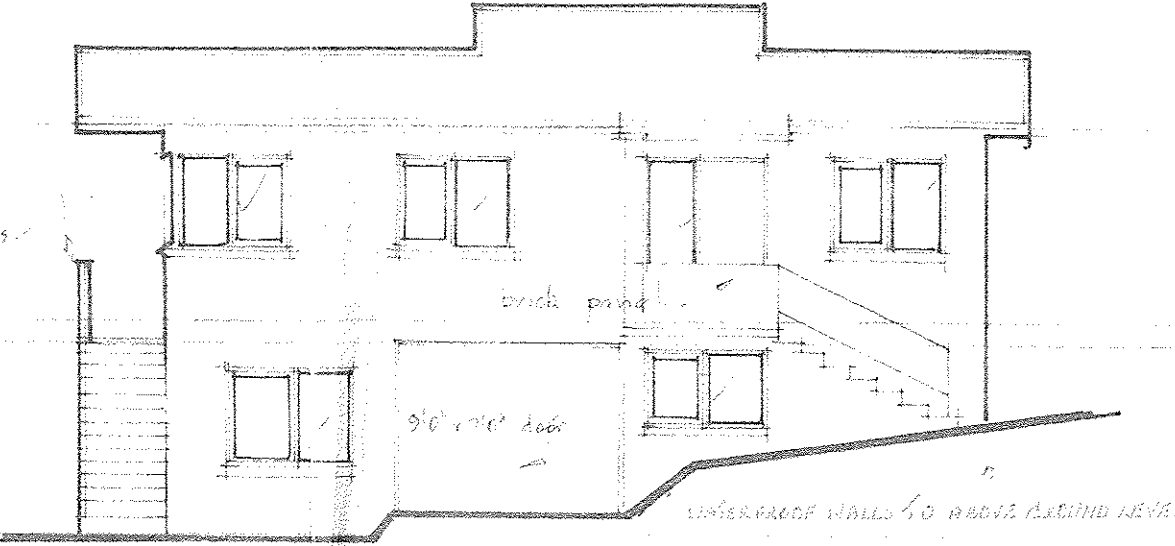

WEST ELEVATION

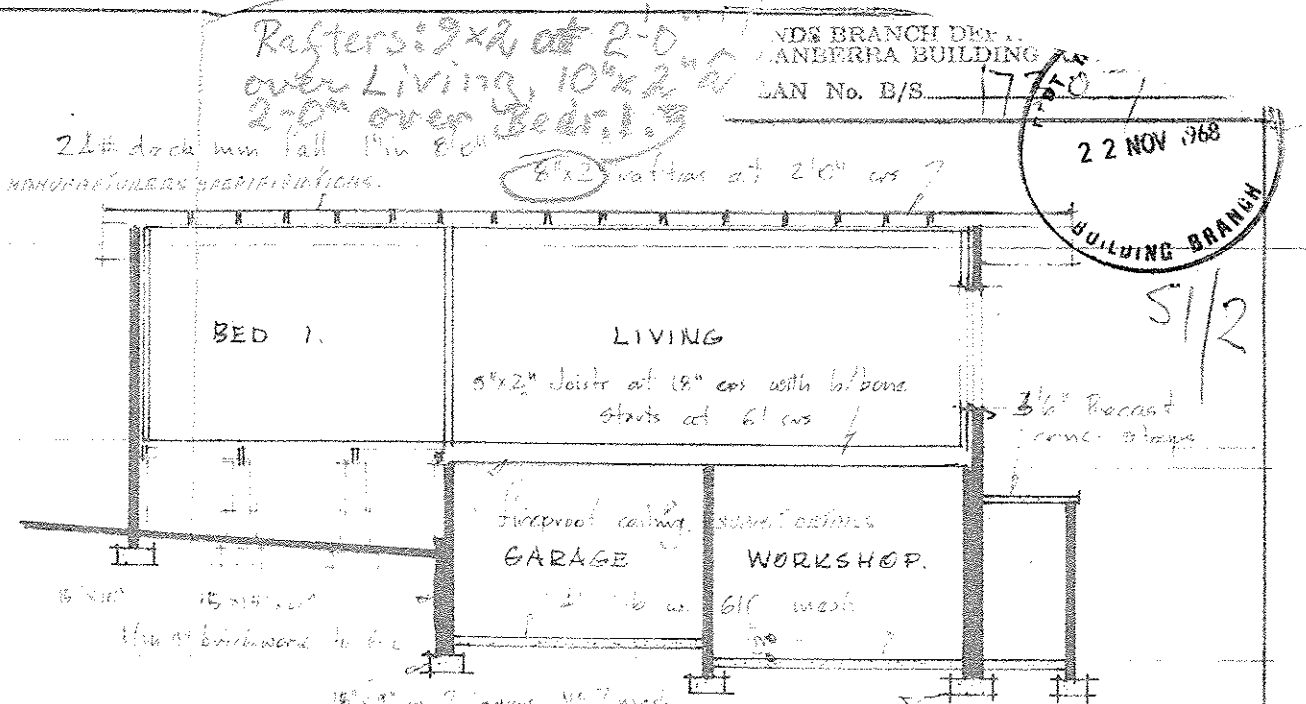
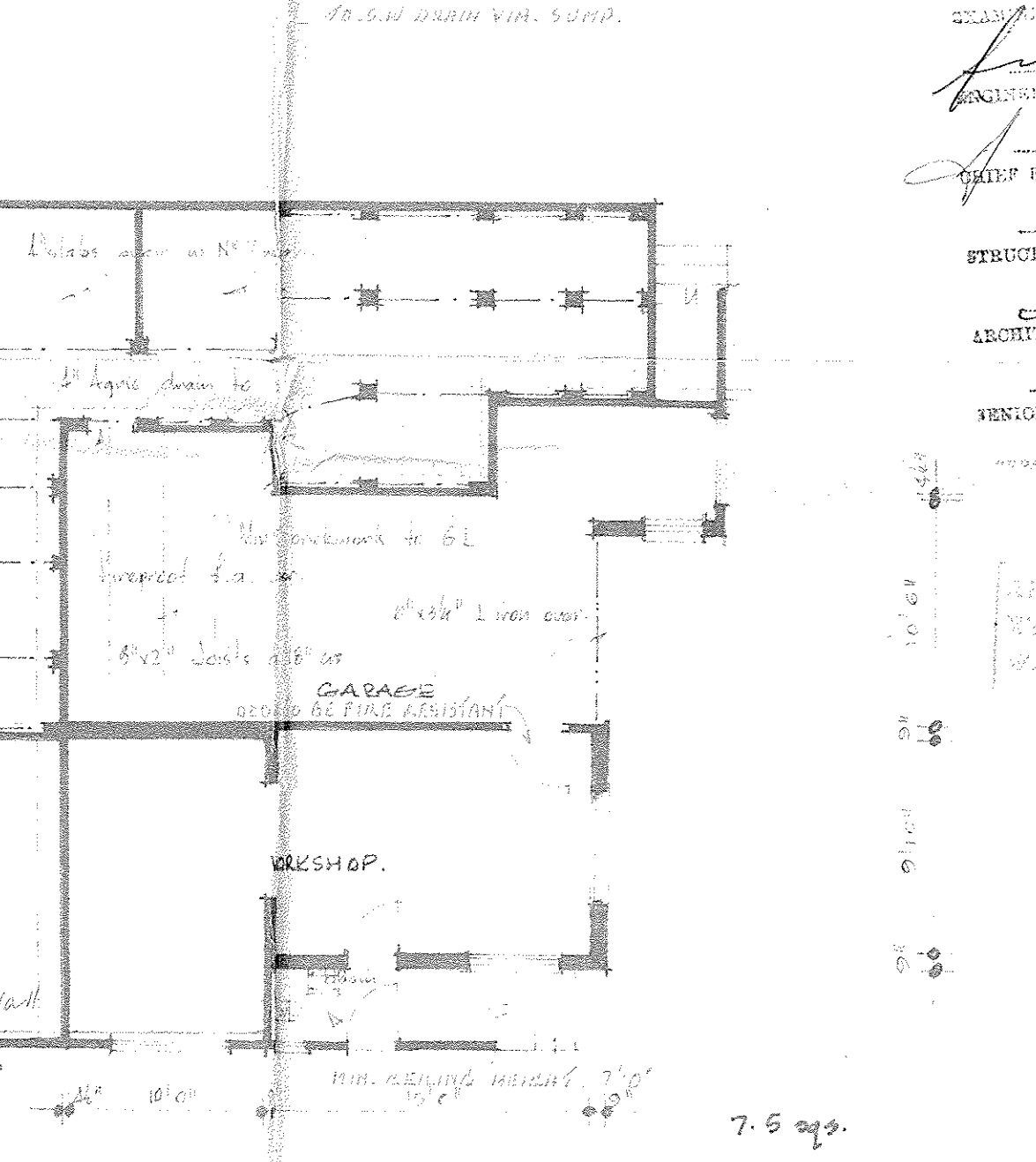

SECTION A-A

No building or garage etc. is to be so sited as to necessitate any variation to the Subdivided Property Line levels or to land created by the site architect WITHOUT PRIOR APPROVAL OF THIS DEPARTMENT.
NO FENCE

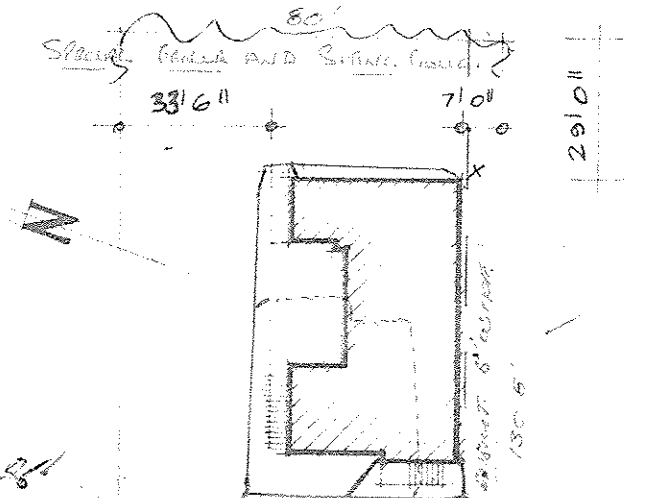

A check survey is to be lodged at the Building Section and no work on this project is to proceed above ground level without prior approval.

DESIGNED BY
 DRAWN BY
 CHECKED BY
 ENGINEER FOR WATER SUPPLY AND POWER
 ARCHITECT AND VALUER
 SENIOR TECHNICAL OFFICER
 APPROVED
 PROPER AUTHORITY
 130 DEC 1968

Approval GRANTED as to External Design and Siting
 Date 20 NOV 1968
 NATIONAL DEVELOPMENT COMMISSION

PROPOSED RESIDENCE • BLOCK 19 • SECTION 28 • ARANDA • FOR R.W. GALLOWAY

WILLIAM H. OWEN DRAFTING SERVICE • 9 JAMES PLACE • CURTIN • 814403.

AREA 26.00 sqs. 1" = 31'0" DWG NO R245

22 NOV 1968
 BUILDING BRANCH

NOV 1968

BUILDING BRANCH

22 NOV 1968

BUILDING BRANCH

5/12

Trade off on 1/2" with (1/2")

2' x 10" 1/2" x 60" x 10"

2' x 60" x 10"

2' x 60"

SECTION A.A

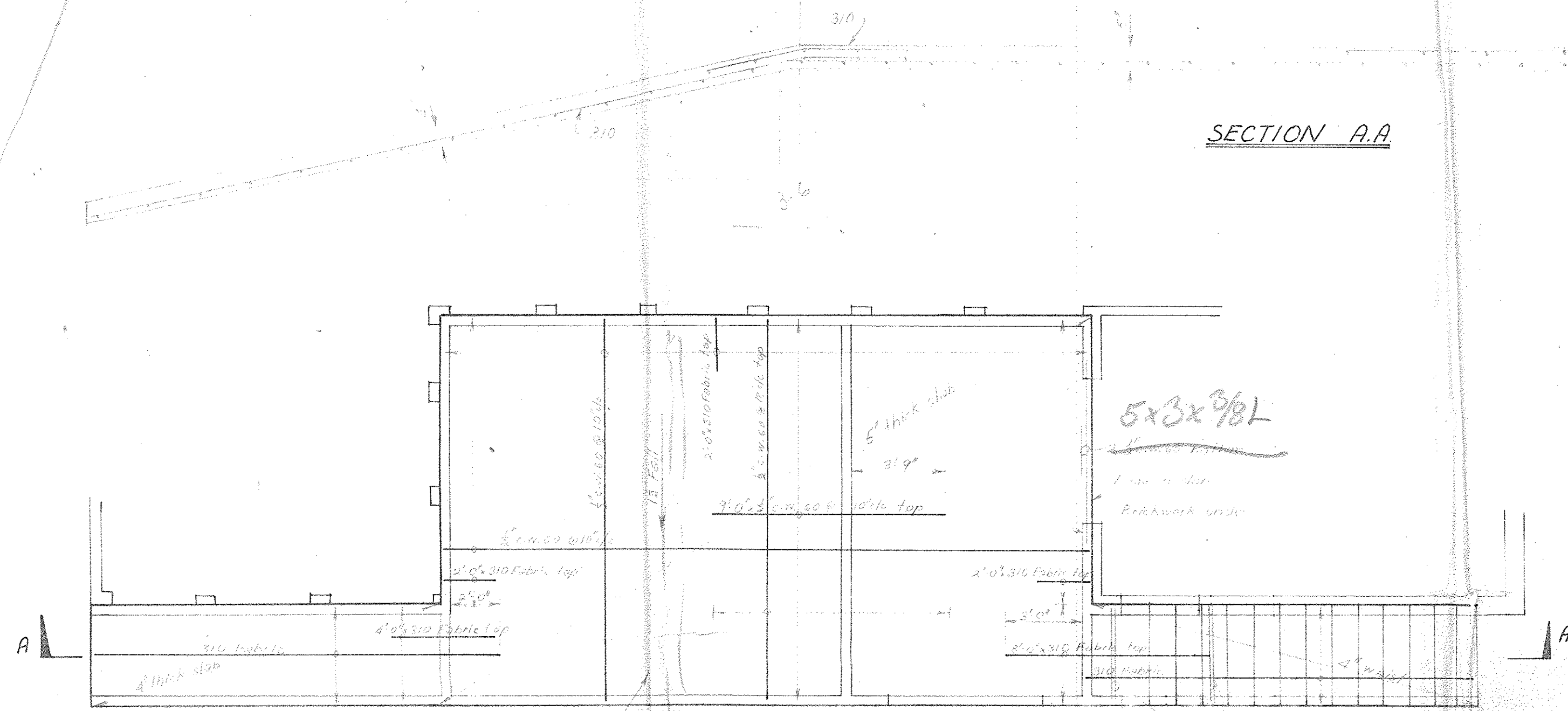

- NOTES:-
1. Concrete $f_c = 3000 \text{ p.s.i.}$
 2. Concrete cover to reinforcement to be 1" top, 1" bottom.
 3. No splicing of reinforcement permitted. Side laps in table, min. 4"

APPROVED
 COMPLIANCE
 172/68
 1968

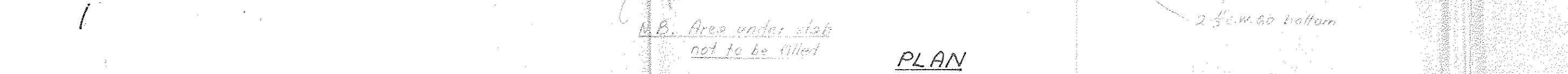

PLAN

A.B. Area under slab not to be filled

Reo in slab to opp hand
 See amended Arch's Drg.
 27 FEB 1969

PROPOSED RESIDENCE • BLOCK 19 • SECTION 28 • ARANDA • for R.W. GALLOWAY

STRUCTURAL DETAILS

Scale. $\frac{1}{4}" = 1'-0"$

EXAMINED BY
 ENGINEER FOR WATER SUPPLY AND SEWERAGE
 2/12/68
 ELECTRICAL ENGINEER
 3 DEC 1968
 STRUCTURAL ENGINEER
 30 12 68
 ARCHITECT AND VALUER
 9 1 1968
 SENIOR TECHNICAL OFFICER
 11
 PROPER AUTHORITY
 30 DEC 1968

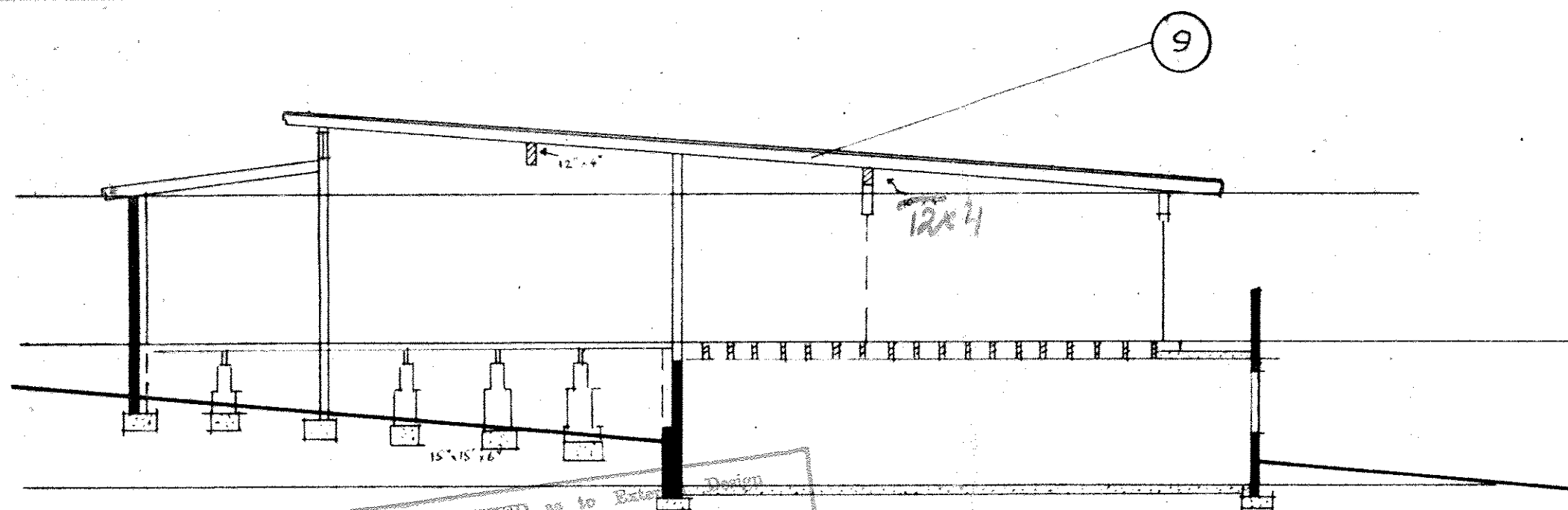

SECTION 9

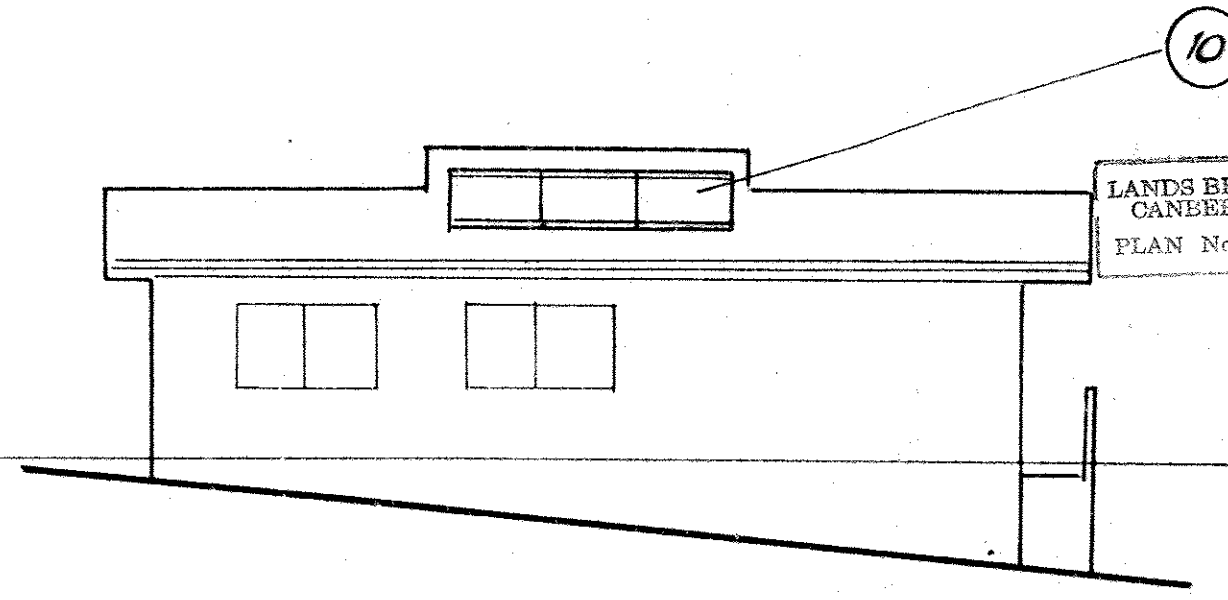

SECTION 10

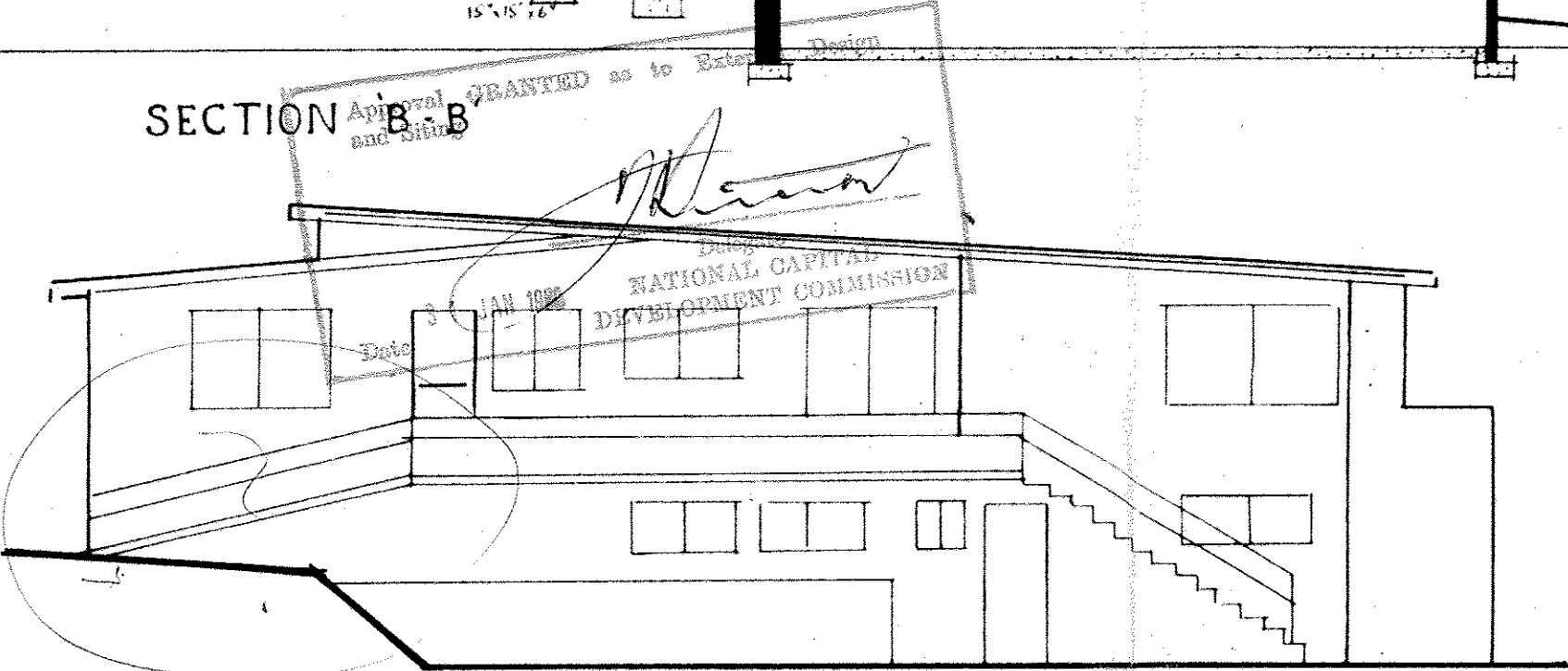

NORTH ELEVATION

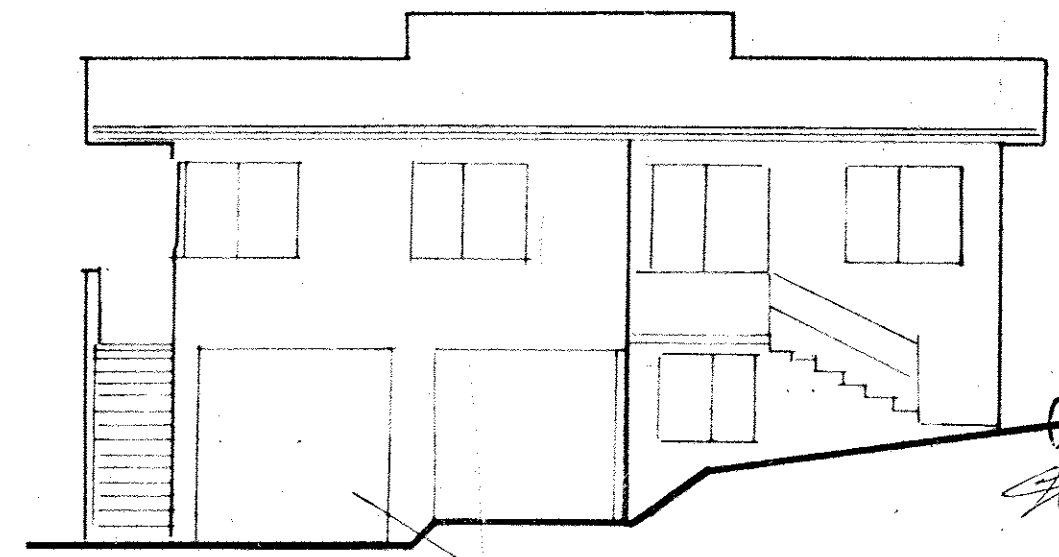

WEST ELEVATION

PLANS AND SPECIFICATIONS EXAMINED AND RECOMMENDED FOR APPROVAL

EXAMINED BY: *[Signature]* 31/1/69
 ENGINEER FOR WATER SUPPLY AND SEWERAGE

OFFICE ELECTRICAL ENGINEER: *[Signature]* 4/2/69

STRUCTURAL ENGINEER: _____ / 1/18

ARCHITECT AND VALUER: _____ / 1/18

SENIOR TECHNICAL OFFICER: *[Signature]* 2/1/69

APPROVED: *[Signature]* 1/18

INSPECTOR AUTHORITY: _____

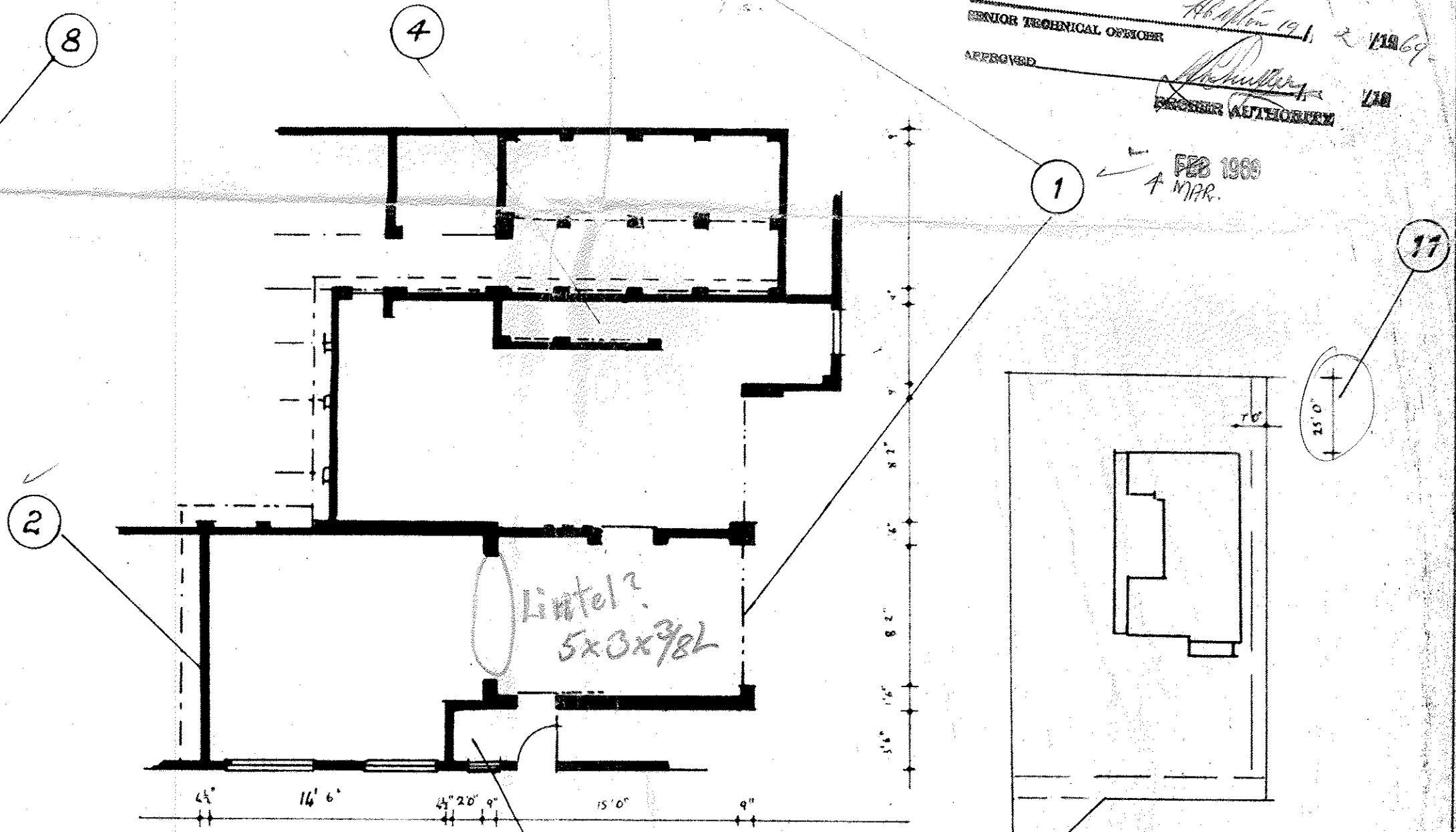
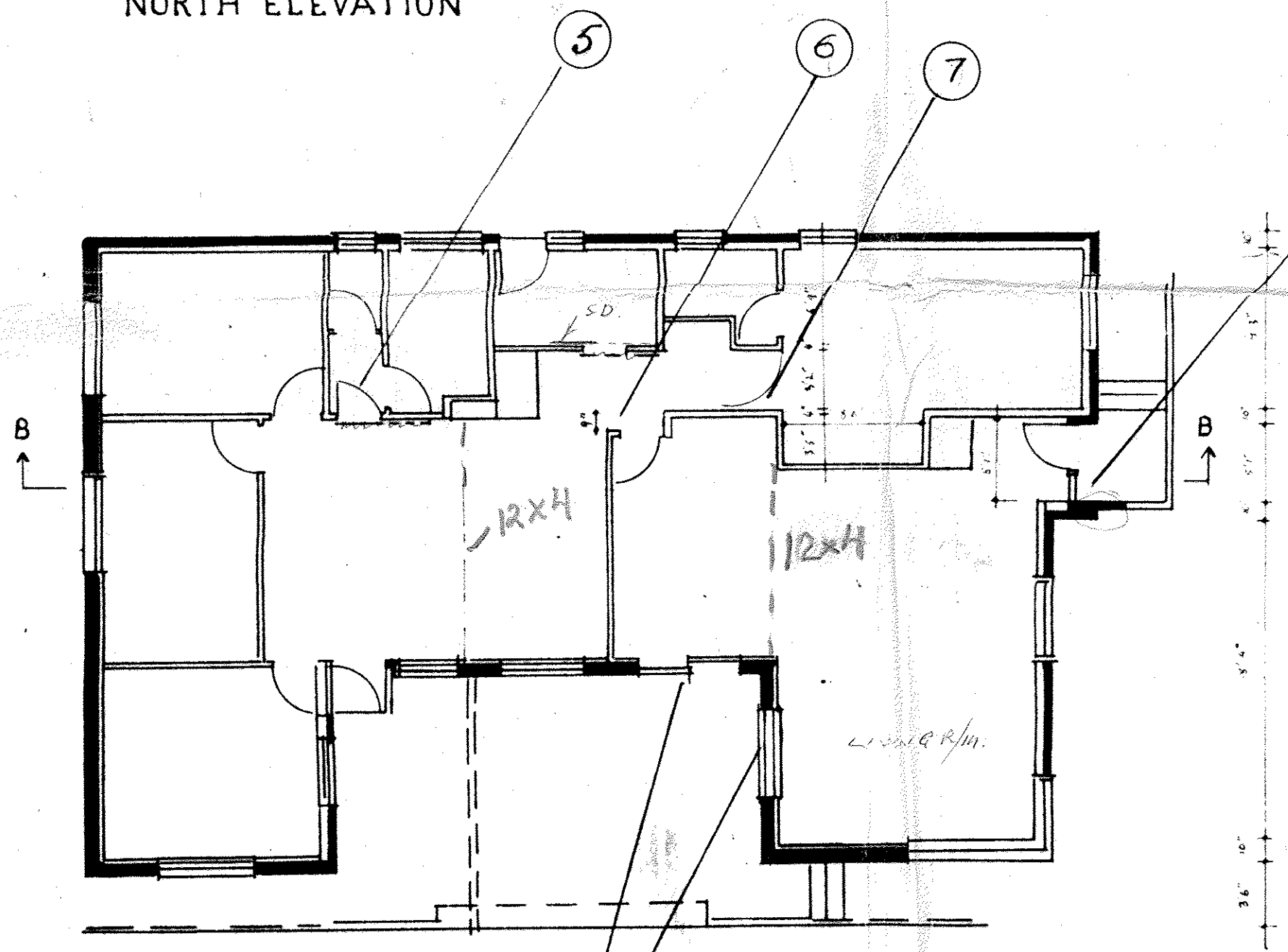

AMENDMENTS TO PROPOSED RESIDENCE BLOCK 19. SECTION 28. ARANDA.
 FOR R. W. GALLOWAY



S1/2

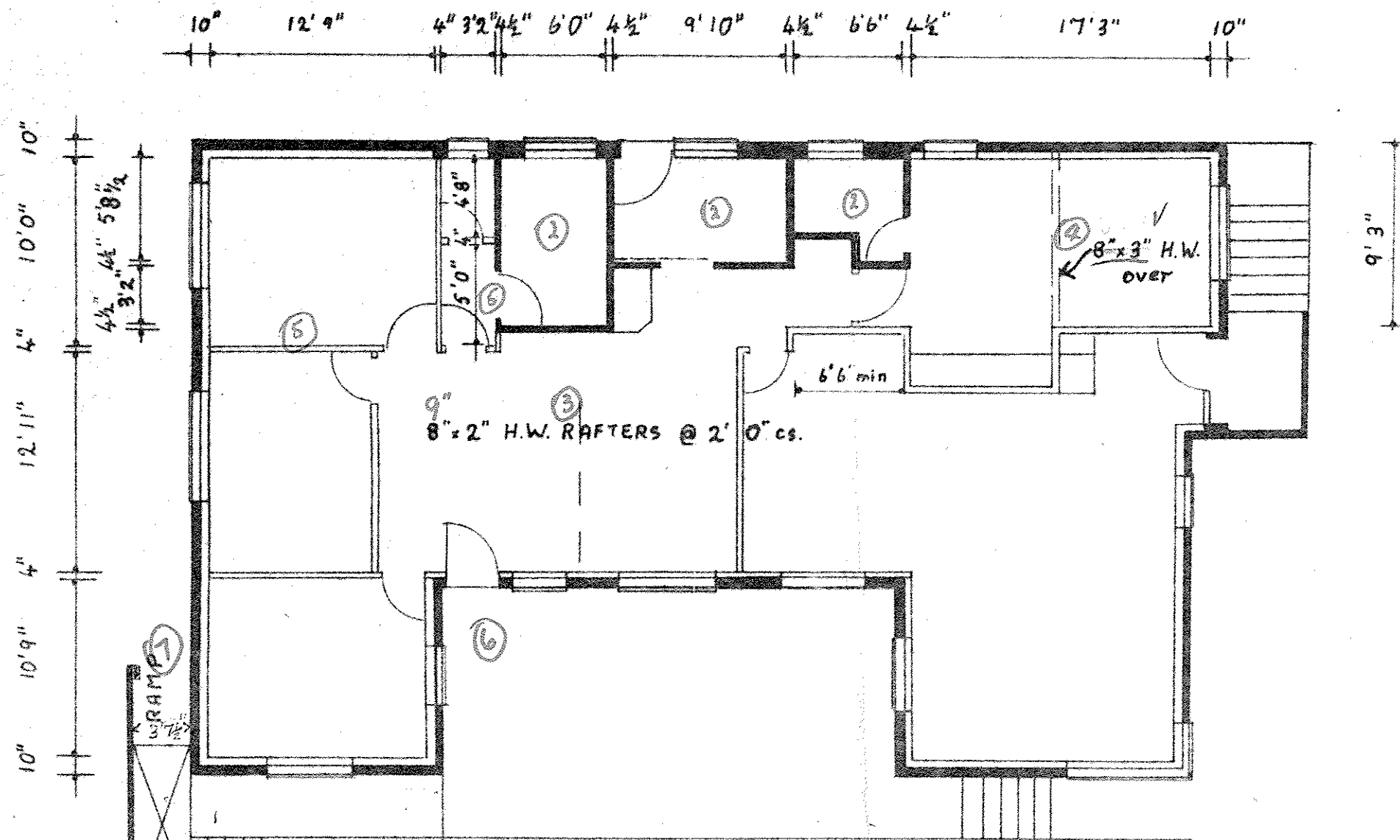

Approval: GRANTED on the External Design and Fixing

OCT 1968

DATE

John Grant

Engineer

NATIONAL CAPITAL DEVELOPMENT COMMISSION

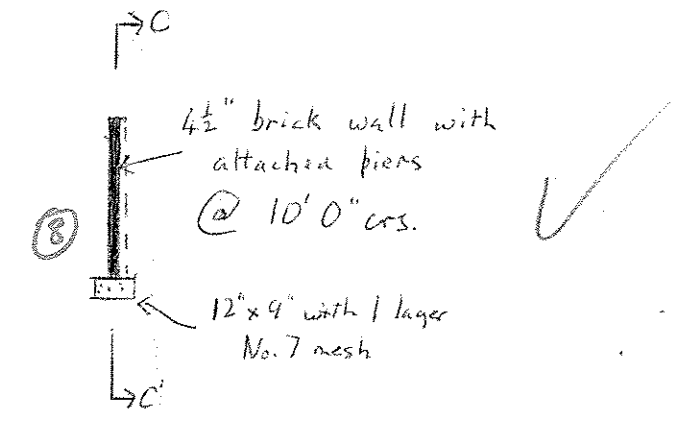
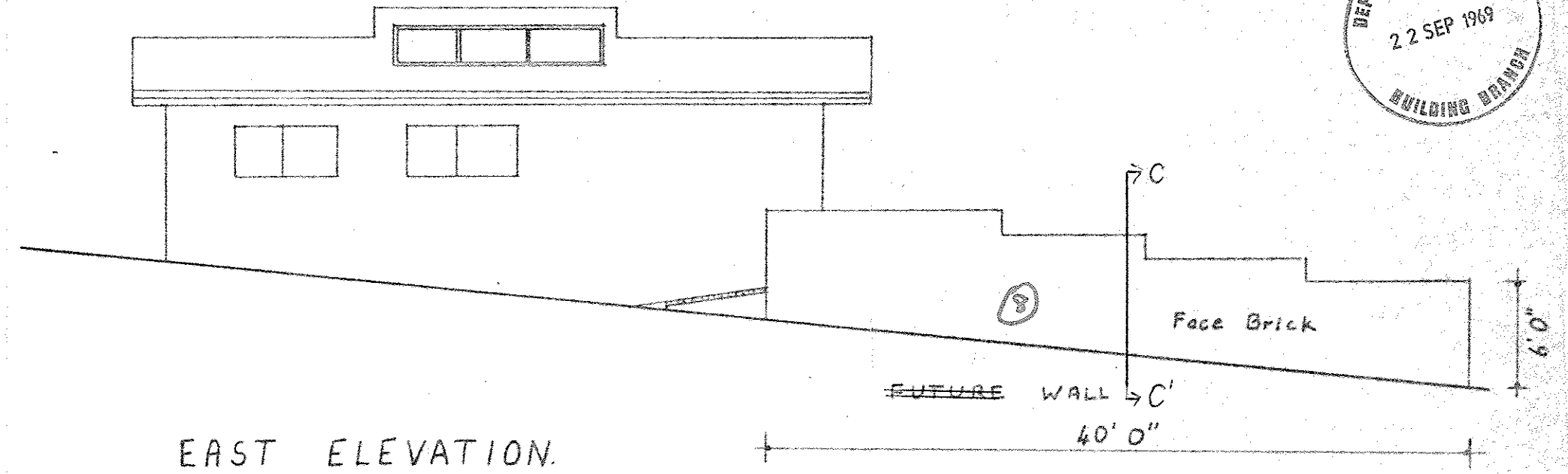

A check survey is to be lodged at the Building Branch and no work on this project is to proceed above ground level without prior approval.

DETAIL OF TERRACE SUPPORT

DETAIL OF FLOOR SUPPORT

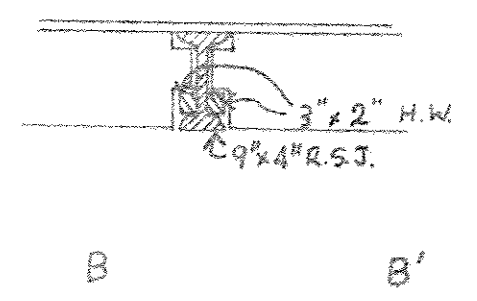
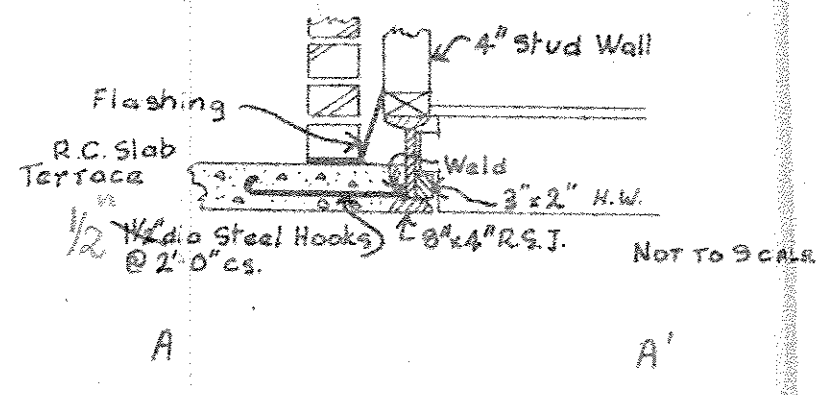

DETAILS OF PROPOSED RESIDENCE
 BLOCK 19, SECTION 28, ARANDA,
 FOR R. W. GALLOWAY.

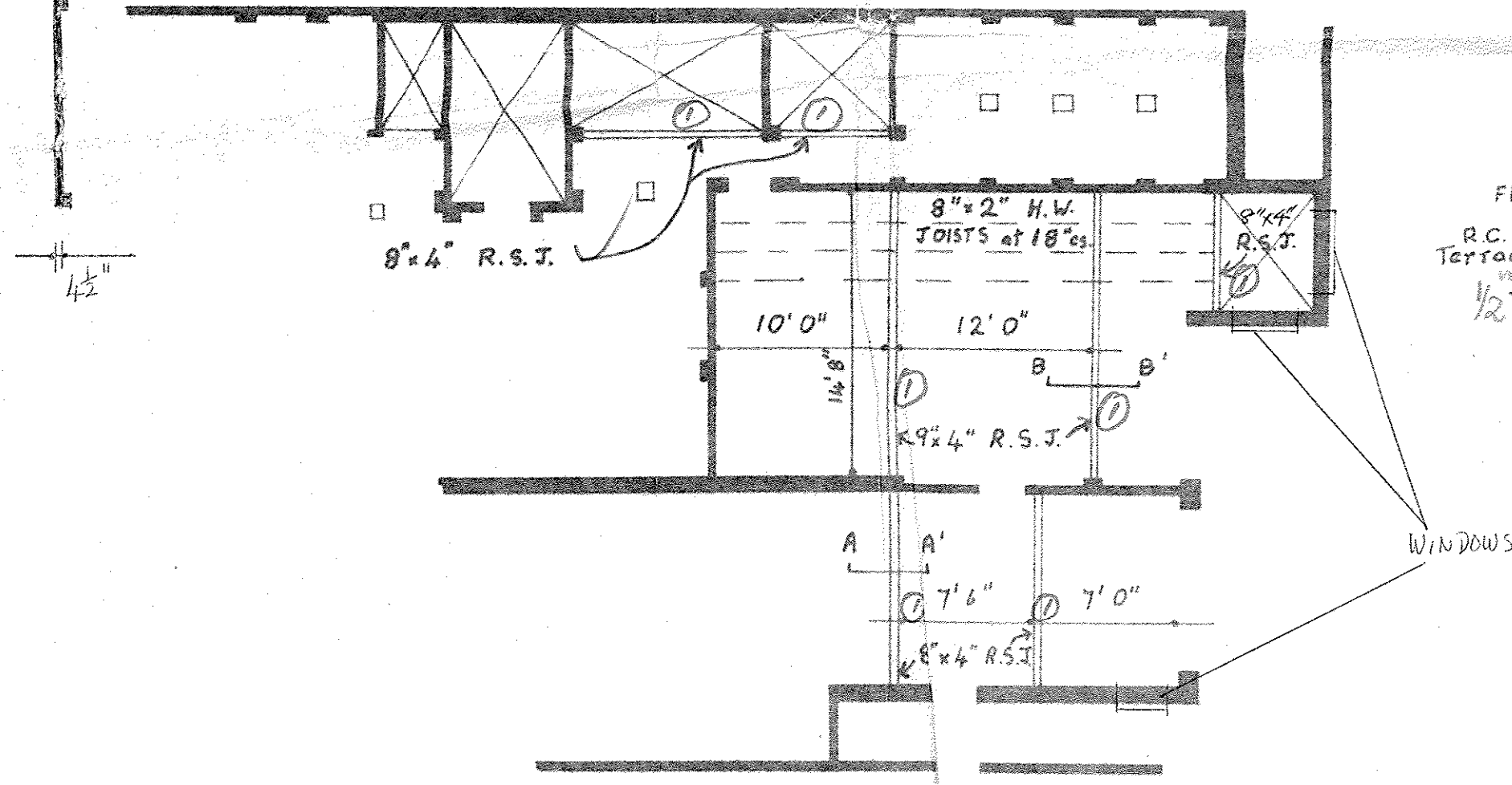

S1/2

PLANS/FILE No. 17307/C
DEPT. OF INTERIOR
BUILDING BRANCH

RECEIVED
24 APR 1970

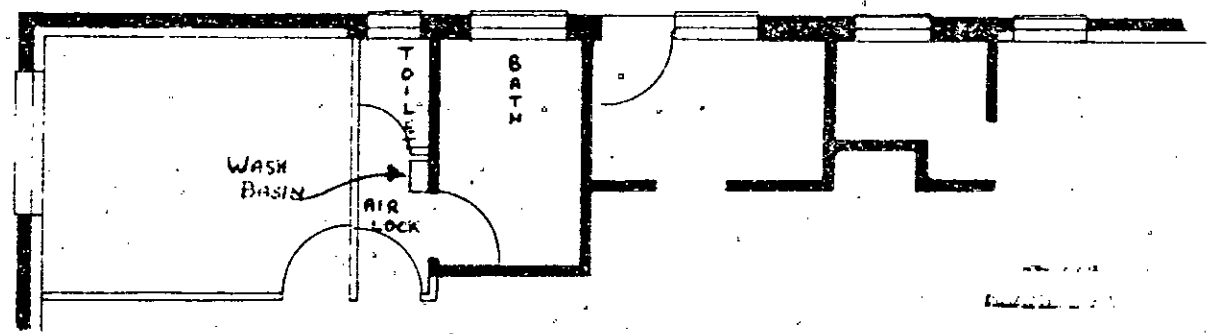

WASH BASIN IN AIR LOCK

AMENDED DRAINAGE PLAN
REQUIRED.

BLOCK 19 SECTION 28 ARANDA

FOR R.W. GALLOWAY

.....	710
.....	712
.....	719
.....	719
.....	719
.....	719

J. Wright 28.4.70
J. M. ...

5 MAY 1970

RECEIVED
 24 APR 1970
 INTERIOR
 BUILDING BRANCH

23

51

Bryde.

BS.17307.

Dear Sir and Madam,

Re: Block 19, Section 28, Aranda.

I certify that the steps and landings to the residence have been completed in accordance with approved plan numbered 17307/D.

Yours faithfully,



(V. C. Bryde)
Deputy Proper Authority.

- 1 MAR 1971

Mr R.W. & Mrs N.G. Galloway,
68 Barada Crescent,
Aranda, A.C.T. 2614.

Copy to:

Mr H. Lindkvist,
14 Sabine Close,
Garran, A.C.T. 2605.

7
11/27/14
11/27/14
11/27/14
11/27/14

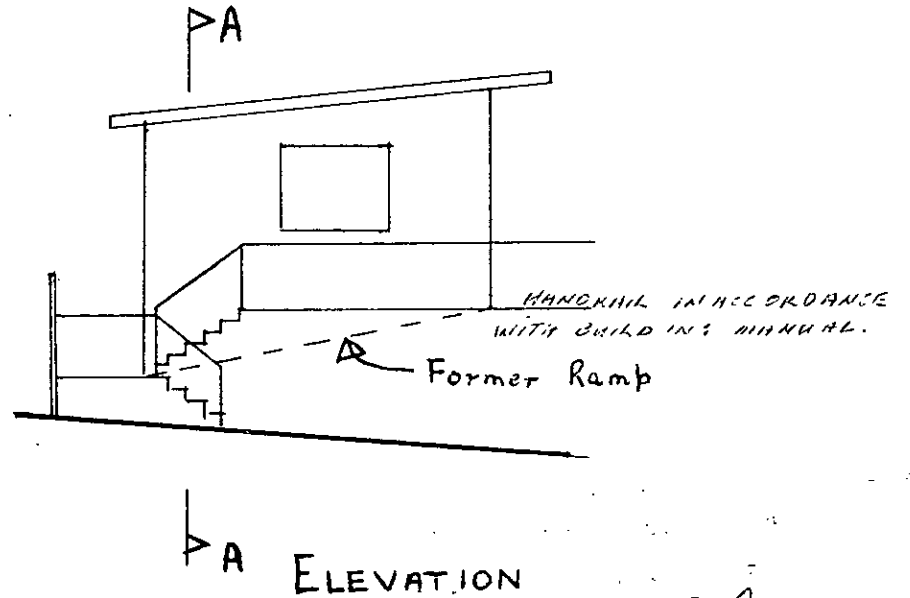
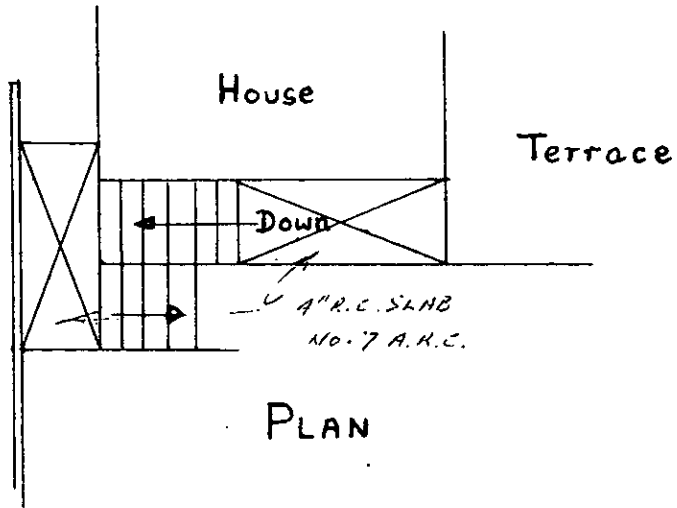

[Handwritten signature]

STEPS REPLACING RAMP
BLOCK 19 SECTION 28 ARANDA
FOR R.W. & N.G. GALLOWAY

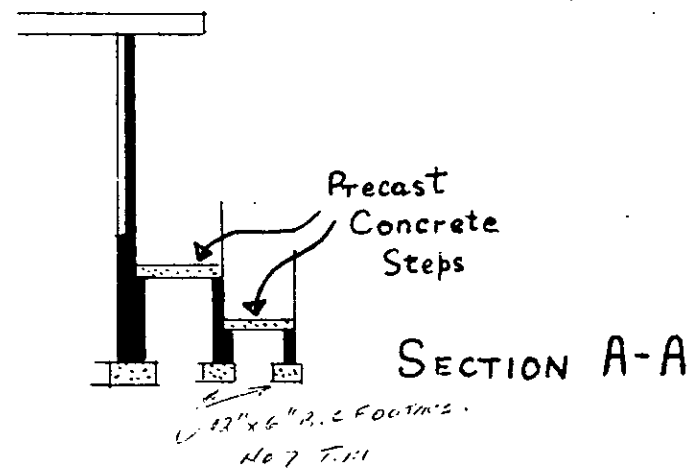

REFERENCE

- G.T. GULLY TRAP
- D.T. DISCONNECTOR TRAP
- C.I.P. CAST IRON PIPE
- E.J. EXPANSION JOINT
- S.P.D. STONWARE PIPE DRAIN
- S.V.P. SOIL VENT PIPE
- V.P. VENTILATING PIPE
- E.V. EDUCT VENT
- I.O. INSPECTION OPENING
- F.P. FIXED POINT
- J.U. JUMP UP
- V.R. VERTICAL RISER



PLAN OF SANITARY DRAINAGE

for

OWNER: R.W. GALLOWAY

BLOCK: 19

SECTION: 28, ARANDA

SCALE: 1:500

NOTE: All work must be carried out in conformity with the Canberra Sewerage and Water Supply Regulations.

ADDITIONAL WORK

FIXTURES:	No. off
1. W. CLOSET	()
2. BATH	()
3. BASIN	()
4. SHOWER	()
5. SINK	()
6. TROUGH	()
7. URINAL	()
8. CLEANER'S SINK	()
9. WASTE DISPOSAL UNIT	()
10. BIDET	()

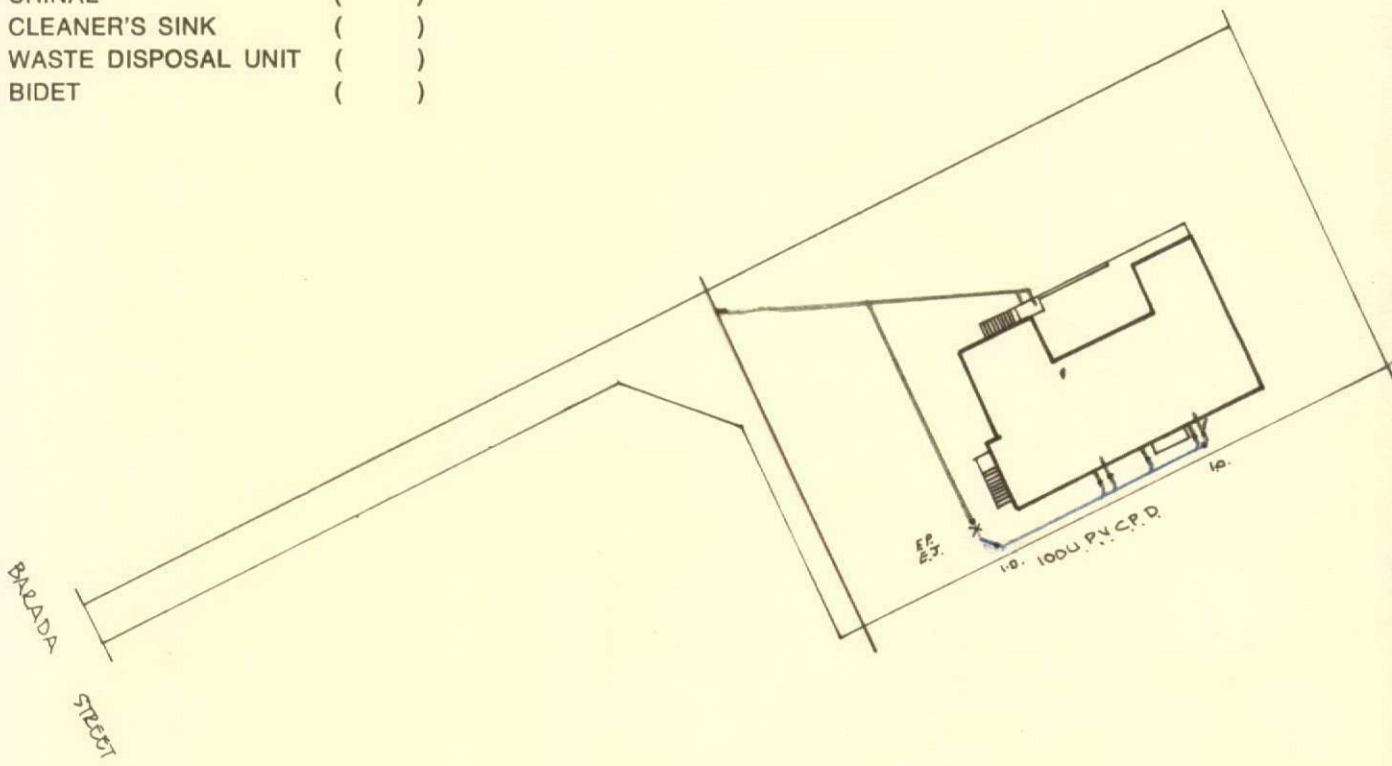

NOTE:

1. DRAINS TO BE LAID SHOWN IN BLUE LINES.
2. THIS PLAN TO BE READ IN CONJUNCTION WITH APPROVED ARCHITECTURAL PLANS AND SPECIFICATIONS.
3. DRAINS TO BE SUPPORTED ON OR FROM SOLID GROUND.
4. SEWER BRANCH TO BE LOCATED ON SITE BEFORE ANY WORK IS COMMENCED.
5. EXISTING DRAINS SHOWN IN GREEN LINES—EXISTING DRAINS X'ED IN RED TO BE ABOLISHED TO APPROVAL.
6. UNPLASTICISED POLYVINYL CHLORIDE PIPE DRAINS (U.P.V.C.P.D.) TO BE CONSTRUCTED IN ACCORDANCE WITH A.S.C.A.87-1972 AND CANBERRA CODES OF PRACTICE.
7. DRAINS UNDER BUILDING MUST BE RETESTED—DRAINS HAVING CEMENT JOINTS. MUST BE TOTALLY SURROUNDED WITH CEMENT CONCRETE 150 MM THICK.
8. THIS PLAN SUPERSEDES DRAINAGE PLAN No. _____ DATED _____ PREVIOUSLY ISSUED.

[Signature]
Sewerage Engineer
17. 3. 1977

FirstRate Report

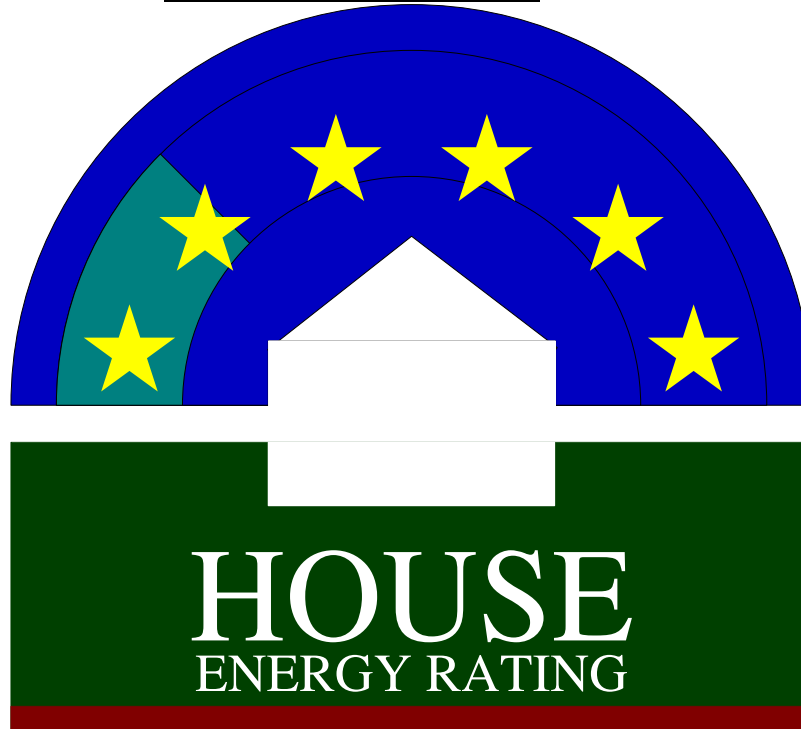

YOUR HOUSE ENERGY RATING IS: ★ ☆
in Climate: 24

1.5 STARS

SCORE: -54 POINTS

Name: Galloway

Ref No: 12934

House Title: Block 19 Section 28 Aranda

Date: 17-04-2015

Address: 68 Barada Crescent, Aranda ACT 2614

Reference: C:\...\EER 68 BARADA CR ARANDA

**ACT HOUSE ENERGY
RATING SCHEME**

-54 Points 1.5 Stars

Robert Lowe - 20111129

Building Assessor - Class A (Energy Efficiency)

This rating only applies to the floor plan, construction details, orientation and climate as submitted and included in the attached Rating Summary. Changes to any of these could affect the rating.

Appliance Ratings

Heating: Unknown Heater / Unknown Rating

Cooling: Unknown Cooling / Unknown Rating

HotWater: Unknown Hot Water System / Unknown Rating

The appliance ratings above are based on information provided by the applicant and are included for information purposes only. They do not affect the House Energy Rating of the dwelling.

IMPROVING YOUR RATING

The table below shows the current rating of your house and its potential for improvement.

Star Rating	POOR			AVERAGE				GOOD			V. GOOD	
	0 Star	★	★★	★★★	★★★★	★★★★★	★★★★★★	★★★★★★★	★★★★★★★★	★★★★★★★★★		
Point Score	-71	-70	-46	-45	-26	-25	-11	-10	4	5	16	17
Current	-54											
Potential	19											

Incorporating these design options will add the additional points required to achieve the potential rating shown in the table. Each point represents about a 1% change in energy efficiency. This list is only a guide to the range of options that could be used.

Design options

Additional points

Change ceiling insulation	R 4	7
Change added wall insulation	R 2.5	50
Change glass to Double Glazing	100 %	8
Change frame to Aluminium-Improved		5
Seal Internal Doors		2

ORIENTATION

Orientation is one of the key factors which influences energy efficiency. This dwelling will achieve different scores and star ratings for different orientations.

Current Rating	-54	★☆☆
-----------------------	------------	------------

Largest windows in the dwelling;

Direction : North East

Area : 11 m²

The table below shows the total score for the dwelling when these windows face the direction indicated.

Note that obstructions overshadowing windows have been removed from all windows in these ratings to allow better comparisons to be made between orientations.

ORIENTATION	POINT SCORE	STAR RATING
1. North East	-53	★☆☆
2. East	-54	★☆☆
3. South East	-57	★
4. South	-60	★
5. South West	-62	★
6. West	-60	★
7. North West	-57	★
8. North	-53	★☆☆

FirstRate Mode
Climate: 24

RATING SUMMARY for: Block 19 Section 28 Aranda, 68 Barada Crescent, Aranda ACT 2614,

Assessor's Name: Robert Lowe 20111126

Net Conditioned Floor Area: 139.2 m²

Feature		Points				
		Winter	Summer	Total		
CEILING		-1	-1	-2		
Surface Area:	0	Insulation:	-2			
WALL		-46	0	-46		
Surface Area:	-23	Insulation:	-22	Mass:		
				0		
FLOOR		4	-2	2		
Surface Area:	0	Insulation:	2	Mass:		
				0		
AIR LEAKAGE (Percentage of score shown for each element)		6	0	5		
Fire Place	0 %	Vented Skylights	0 %			
Fixed Vents	0 %	Windows	36 %			
Exhaust Fans	0 %	Doors	50 %			
Down Lights	0 %	Gaps (around frames)	14 %			
DESIGN FEATURES		0	1	1		
Cross Ventilation	1					
ROOF GLAZING		0	0	0		
Winter Gain	0	Winter Loss	0			
WINDOWS		-8	-13	-21		
Window Direction	Area		Point Scores			
	m2	%NCFA	Winter* Loss	Winter Gain	Summer Gain	Total
NE	11	8%	-13	15	-4	-2
SE	10	7%	-13	4	-3	-11
SW	4	3%	-4	2	-2	-3
NW	8	6%	-10	10	-4	-4
Total	34	24%	-40	31	-13	-21
* Air movement over glazing can significantly increase winter heat losses. SEAV recommends heating/cooling duct outlets be positioned to avoid air movement across glass or use deflectors to direct air away from glass.						
The contribution of heavyweight materials to the window score is -1 points						
			Winter	Summer	Total	
RATING	★ ☆		SCORE	-47	-14	-54*

* includes 7 points from Area Adjustment

Detailed House Data

House Details

ClientName Galloway
HouseTitle Block 19 Section 28 Aranda
StreetAddress 68 Barada Crescent, Aranda ACT 2614
AssessorName Robert Lowe 20111126
FileCreated 17-04-2015

Climate Details

State
Town Canberra
Postcode 2600
Zone 24

Floor Details

ID	Construction	Sub Floor	Upper	Shared	Foil	Carpet	Ins RValue	Area
1	Timber	Enclosed	No	No	No	No	R0.5	28.0m ²
2	Timber	Enclosed	No	No	No	Carp	R0.5	90.0m ²
3	Timber	Enclosed	No	No	No	Vinyl	R0.5	32.0m ²
4	Suspended Slab	Enclosed	No	No	No	Tiles	R0.0	4.0m ²

Wall Details

ID	Construction	Shared	Ins RValue	Length	Height
1	Brick Veneer	No	R0.0	59.2m	2.8m

Ceiling Details

ID	Construction	Shared	Foil	Ins RValue	Area
1	Flat - Framed	No	Yes	R2.0	154.0m ²

Window Details

ID	Dir	Height	Width	Utility	Glass	Frame	Curtain	Blind	Fixed & Adj Eave	Fixed Eave	Head to Eave
1	NW	2.0m	0.6m	No	SG	TIMB	NC	No	0.6m	0.6m	0.3m
2	NW	1.4m	1.2m	No	SG	ALSTD	HP	Yes	0.6m	0.6m	0.3m
3	NW	1.4m	1.2m	No	SG	ALSTD	HP	No	0.6m	0.6m	0.3m
4	NE	1.4m	2.2m	No	SG	ALSTD	HP	No	1.0m	1.0m	0.5m
5	SE	1.4m	1.2m	No	SG	ALSTD	HP	No	4.0m	4.0m	1.2m
6	NE	2.0m	1.8m	No	SG	ALSTD	HP	No	2.0m	2.0m	1.2m
7	NE	0.9m	1.5m	No	SG	ALSTD	HB	No	2.0m	2.0m	1.2m
8	NE	2.0m	0.7m	No	SG	ALSTD	HP	No	2.0m	2.0m	1.2m
9	NW	1.4m	1.2m	No	SG	ALSTD	HD	No	2.0m	2.0m	1.2m
10	NE	1.0m	1.0m	No	SG	ALSTD	HD	No	1.0m	1.0m	0.8m
11	SE	1.0m	1.8m	No	SG	ALSTD	HD	No	0.6m	0.6m	0.1m
12	SE	1.0m	1.8m	No	SG	ALSTD	HD	No	0.6m	0.6m	0.1m
13	SE	1.0m	1.8m	No	SG	ALSTD	HP	No	0.6m	0.6m	0.1m
14	SW	0.6m	0.8m	Yes	SG	ALSTD	NC	No	0.0m	0.0m	0.0m
15	SW	0.6m	1.5m	Yes	SG	ALSTD	NC	No	0.0m	0.0m	0.0m
16	SW	1.0m	1.2m	Yes	SG	ALSTD	NC	No	0.0m	0.0m	0.0m
17	SW	0.6m	0.8m	No	SG	ALSTD	NC	No	0.0m	0.0m	0.0m
18	SW	0.7m	0.8m	No	SG	ALSTD	HP	No	0.0m	0.0m	0.0m
19	NW	0.9m	2.2m	No	SG	ALSTD	HP	No	0.6m	0.6m	0.3m
20	NE	1.5m	0.5m	No	SG	TIMB	NC	No	0.6m	0.6m	0.1m
21	SW	1.5m	0.5m	No	SG	TIMB	NC	No	0.6m	0.6m	0.1m
22	SE	0.8m	3.9m	No	SG	TIMB	NC	No	0.6m	0.6m	0.1m

Window Shading Details

<u>ID</u>	<u>Dir</u>	<u>Height</u>	<u>Width</u>	<u>Obst Height</u>	<u>Obst Dist</u>	<u>Obst Width</u>	<u>Obst Offset</u>	<u>LShape Left Fin</u>	<u>LShape Left Off</u>	<u>LShape Right Fin</u>	<u>LShape Right Off</u>
5	SE	1.4m	1.2m	4.0m	6.0m	15.4m	-3.5m	0.0m	0.0m	6.0m	0.9m
6	NE	2.0m	1.8m	0.0m	0.0m	0.0m	0.0m	4.0m	0.3m	0.0m	0.0m
8	NE	2.0m	0.7m	0.0m	0.0m	0.0m	0.0m	0.0m	0.0m	4.0m	1.1m
9	NW	1.4m	1.2m	4.0m	6.0m	13.4m	-11.0m	6.0m	0.9m	0.0m	0.0m

Zoning Details

Is there Cross Flow Ventilation ? Good

Air Leakage Details

Location Suburban
 Is there More than One Storey ? No
 Is the Entry open to the Living Area ? Yes
 Is the Entry Door Weather Stripped ? Yes
 Area of Heavyweight Mass 0m²
 Area of Lightweight Mass 0m²

	<u>Sealed</u>	<u>UnSealed</u>
Chimneys	0	0
Vents	0	0
Fans	0	0
Downlights	0	0
Skylights	0	0
Utility Doors	0	3
External Doors	0	2

Unflued Gas Heaters 0
 Percentage of Windows Sealed 98%
 Windows - Average Gap Small
 External Doors - Average Gap Small
 Gaps & Cracks Sealed Yes

TIMBER PEST INSPECTION REPORT

Prepared in accordance with

Australian Standard AS 4349.3 "Inspection of Buildings Part 3"

68 Barada Crescent

Aranda ACT 2614

Visual Timber Pest Inspection & Report in accordance with AS 4349.3

Address of Property Inspected	68 Barada Crescent, Aranda ACT 2614
Surname of Property Owner	Galloway
Inspection Date	Friday, 17 April 2015

Summary Sheet

This summary is supplied to allow a quick and superficial overview of the Inspection results. This summary is NOT the Report and cannot be relied upon on its own. This summary must be read in conjunction with the full Report and not in isolation from the Report. If there should happen to be any discrepancy between anything in the Report, and anything in this summary, the information in the Report shall override that in the summary. The Report is subject to conditions and limitations. Your attention is particularly drawn to the clauses, disclaimer of liability to third parties, limited liability to a purchaser with the Australian Capital Territory (ACT), and to the notice to the purchaser at the back of this Report.

1. **TERMITE ACTIVITY**

Visible evidence of subterranean termite workings or damage was found. Please refer to Section 2.0 of the Pest Report for further information.

Active subterranean termites (live specimens) were found. Please refer to Section 2.0 of the Pest Report for further information.

2. **BORER ACTIVITY**

No visible evidence of borers of seasoned timbers was found

3. **DECAY FUNGI**

Evidence of timber wood decay found. Please refer to Section 4.0 of the Pest Report.

For complete and accurate information, please refer to the attached 'Visual Timber Pest Report', which is prepared in accordance with AS 4349.3.

Conditions of this Inspection

1. IMPORTANT INFORMATION: Any person who relies upon the contents of this Report does so acknowledging that the following clauses, which define the scope and limitations of the Inspection, form an integral part of the Report.

This is a **Visual Inspection Only**, prepared in accordance with AS 4349.3, 'Inspection of Buildings Part 3: Timber Pest Inspections'.

Visual Inspection was limited to those areas and sections of the property to which reasonable access (see definition) was both available and permitted on the date of Inspection.

The Inspection **did not** include breaking apart, dismantling, removing or moving objects including; but not limited to – foliage, mouldings, roof insulation/sisalation, floor or wall coverings, sidings, ceilings, floors, furnishings, appliances or personal possessions.

The Inspector **cannot** see inside walls, between floors, inside skillion roofing, inside the eaves, behind stored goods in cupboards, or in any other areas that are concealed or obstructed.

The Inspector **did not** dig, gouge, force or perform any other invasive procedures. An invasive Inspection will not be performed unless a separate contract is entered into.

In an occupied property, it must be understood that furnishings or household items may be concealing evidence of Timber Pests, which may only be revealed when the items are moved or removed.

In the case of strata type properties, only the interior of the unit is inspected.

2. SCOPE OF REPORT: This Report only deals with the detection or non-detection of Timber Pest Attack and Conditions Conducive to Timber Pest Attack discernible at the time of inspection. The inspection was limited to the Readily Accessible Areas of the Building and Site (see note below) and was based on a visual examination of surface work (excluding furniture and stored items), and the carrying out of Tests. Note. With strata and company title properties, the inspection was limited to the interior and the immediate exterior of the particular residence inspected. Common property was not inspected.

3. Limitations

The Client acknowledges:

A. This Report does not include the inspection and assessment of matters outside the scope of the requested inspection and report.

B. The inspection only covered the Readily Accessible Areas of the Building and Site. The inspection did not include areas which were inaccessible, not readily accessible or obstructed at the time of inspection. Obstructions are defined as any condition or physical limitation which inhibits or prevents inspection and may include – but are not limited to – roofing, fixed ceilings, wall linings, floor coverings, fixtures, fittings, furniture, clothes, stored articles/materials, thermal insulation, sarking, pipe/duct work, builder's debris, vegetation, pavements or earth.

C. The detection of dry wood termites may be extremely difficult due to the small size of the colonies. No warranty of absence of these termites is given.

Property: 68 Barada Crescent, Aranda ACT 2614

D. European House Borer (*Hylotrupes bajulus*) attack is difficult to detect in the early stages of infestation as the galleries of boring larvae rarely break through the affected timber surface. No warranty of absence of these borers is given. Regular inspections including the carrying out of appropriate tests are required to help monitor susceptible timbers.

E. This is not a structural damage report. Neither is this a warranty as to the absence of Timber Pest Attack.

F. If the inspection was limited to any particular type(s) of timber pest (e.g. subterranean termites), then this would be the subject of a Special-Purpose Inspection Report, which is adequately specified.

G. This Report does not cover or deal with environmental risk assessment or biological risks not associated with Timber Pests

(e.g. toxic Mould) or occupational, health or safety issues. Such advice may be the subject of a Special-Purpose Inspection Report which is adequately specified and must be undertaken by an appropriately qualified inspector. The choice of such inspector is a matter for the Client.

H. This Report has been produced for the use of the Client. The Consultant or their firm or company are not liable for any reliance placed on this report by any third party, except as provided in the section Limited Liability To a Purchaser within the Australian Capital Territory.

4. **DETERMINING EXTENT OF DAMAGE:** This Report is **not** a structural damage Report. This is not a structural building report, and any inexperienced opinion we provide on timber damage **cannot** be relied upon. This Report **will not** state the full extent of any Timber Pest damage. It will state Timber Pest Damage found as either 'slight', 'moderate', 'moderate to extensive', or 'extensive', and this information is not the opinion of an expert. If any evidence of Timber Pest activity and/or damage resulting from Timber Pest activity is reported, either in the structure(s) or the grounds of the property, then you must assume that there may be concealed structural damage within the building(s). This concealed damage may only be found when wall linings, cladding or insulation are removed to reveal previously concealed timbers. In this case, an Invasive Timber Pest Inspection (for which a separate contract is required) is strongly recommended, and you should arrange for a qualified professional such as a builder, engineer, or architect to carry out a structural Inspection to determine the full extent of the damage, and the extent of repairs that may be required. You agree that neither we, nor the individual conducting the Inspection, are responsible or liable for the repair of any damage; whether disclosed by the Report or not.
5. **DISCLAIMER OF LIABILITY:** No liability shall be accepted on account of failure of the Report to notify any termite activity and/or damage present at, or prior to, the date of the Report, in any area(s) or section(s) of the subject property physically inaccessible for Inspection, or to which access for Inspection is denied by, or to, the licensed Inspector (including, but not limited to, any area(s) or section(s) specified by the Report).

Visual Timber Pest Report

1.1. AREA(S) INSPECTED:

Only structures, fences &/or trees within 50m of the building but within the property boundaries were inspected.

1.2. COMMON AREA(S) NOT INSPECTED:

No Inspection was made, and no Report will be submitted, of inaccessible area(s).

These include, but may not be limited to; cavity walls, concealed frame timbers, eaves, flat roofs, fully enclosed patios, inaccessible parts of the subfloors, inaccessible parts of the roof void, soil concealed by concrete floors, fireplace hearths, wall linings, landscaping, rubbish, floor coverings, furniture, pictures, appliances, stored items, insulation, and hollow blocks/posts etc.

1.3. AREA(S) IN WHICH VISUAL INSPECTION WAS OBSTRUCTED OR RESTRICTED AND WHY:

The roof void, due to the raked ceiling. Furniture and stored items concealed some of the skirting boards and architraves inside the house. Areas of the timber fence were concealed by vegetation. Floor boards in the subfloor region, were concealed by sarking.

NB. Please note that since a complete Inspection of the above area(s) was not possible, Timber Pest activity and/or damage may exist in these areas.

1.4. THE PROPERTY WAS PARTIALLY FURNISHED AT THE TIME OF INSPECTION:

Where a property is furnished at the time of Inspection, it must be understood that the furnishings and stored goods may be concealing evidence of Timber Pest activity. This evidence may be revealed when the property is vacated, and a further Inspection of the vacant property is strongly recommended if the house was furnished at the time of inspection.

1.5. UNDETECTED TIMBER PEST RISK ASSESSMENT IS CONSIDERED Moderate

NB. Where the risk is considered "Moderate" or "Moderate-High" or "High", a further inspection is strongly recommended of areas that were not readily accessible, and of inaccessible or obstructed areas once access has been provided or the obstruction removed. This may require the moving, lifting or removal of obstructions such as floor coverings, furniture, stored items foliage and insulation. In some instances, it may also require the removal of ceiling and wall linings, and the cutting of traps and access holes. Seek further advice from your Consultant

Property: 68 Barada Crescent, Aranda ACT 2614

2.0. SUBTERRANEAN TERMITES:

2.1. Active (live) termites were present at the time of inspection, in garden bed edging timbers, near the front of the property. The termites found were the Coptotermes species. These termites have the capability to cause significant damage to timber including structural damage.

2.2. Visible evidence of subterranean termite workings and/or damage was found, in the above mentioned timbers. Some of the fence palings in the timber fence next to the driveway The damage to the fence timbers has been caused by Heterotermes Ferox which is a species of termites that generally do not attack houses, and cause no structural damage.

2.3. A termite nest was not found.

2.4. Evidence of moderate timber damage was visible.

NB. Where evidence of termite activity was found in the grounds, the risk to buildings is very high. A treatment to eradicate the termites and to protect the building(s) should be carried out. Where the evidence of termite workings was found in the grounds or the building(s), then the risk of a further attack is very high.

2.5. VERY IMPORTANT:

If live termites or any evidence of termite workings or damage was reported above, within the building(s) or in the grounds and fences, then it must be assumed that there may be concealed termite activity and/or timber damage. This concealed activity or damage may only be found when alterations are carried out, such as when wall linings, cladding or insulation are removed; or if you arrange for an invasive Inspection. We claim no expertise in structural engineering or building, and we strongly recommend that you have a qualified professional such as a builder, engineer, architect or other qualified expert determine the full extent of the damage, if any. This may require an invasive Inspection. We take no responsibility for the repair of any damage, whether disclosed by this Report or not (see 'Terms and Limitations').

Where visual evidence of termite workings and/or damage is reported above, but no live termites were present at the time of Inspection, you must realise that it is possible that termites are still active in the immediate vicinity, and that the termites may continue to cause further damage. It is not possible, without further investigation and a number of Inspections over a period of time, to ascertain whether any infestation is active or inactive. Active termites may simply have not been present at the time of Inspection due to a prior disturbance or climatic conditions, or they may have been utilizing an alternative feeding source.

Continued, regular Inspections are essential. Unless written evidence of a termite protection program in accordance with 'AS 3660' with ongoing Inspections is provided, you must arrange for a treatment in accordance with 'AS 3660' to be carried out to reduce the risk of further attack.

2.6. PREVIOUS TERMITE TREATMENT: No signs of a Termite treatment were found or evidence of a possible previous termite treatment.

Property: 68 Barada Crescent, Aranda ACT 2614

NB. If there is evidence of drill holes in concrete or brickwork, bait stations or other signs of a possible previous treatment are reported, then the treatment was probably carried out because of an active termite attack. Extensive structural damage may exist in concealed areas. You should have an invasive Inspection carried out, and have a builder determine the full extent of any damage, and the estimated cost of repairs, as the damage may only be found when wall linings etc. are removed. Normally, if a termite treatment has been carried out, then a durable notice should be located in the metre box, indicating the type of termite shield system, treated zone or combination that has been installed.

2.7. TERMITE MANAGEMENT: A durable notice (termite management notice) was not found during the Inspection, indicating a barrier system has not been installed.

This firm can give no assurances with regard to work that may have been previously performed by other firms. You should obtain copies of all paperwork, and make your own enquiries as to the quality of the treatment when it was carried out, and warranty information. In most cases, you should arrange for a treatment in accordance with "Australian Standard 3660" to be carried out to reduce the risk of further attack.

2.8. GENERAL REMARKS:

Where any current visible evidence of Timber Pest activity is found, it is strongly recommended that a more invasive Inspection be performed. Trees on and near the property up to a height of 2 metres, have been visually Inspected where possible and practicable, for evidence of Termite activity.

It is very difficult to locate termite nests since they are underground, and evidence in trees is usually well concealed. Therefore, we strongly recommend that you arrange to have the medium to large eucalypt trees within a 50 metre radius of the property test drilled for evidence of termite nests.

3. BORERS OF SEASONED TIMBER:

3.1. No visible evidence of borers was found.

General Description of Attack As the attack proceeds, borer larvae eat through the wood leaving a dust called "frass". Ejection of the frass occurs through the adult beetle's flight (exit) holes, and it is usually present beneath any timber that has been attacked. The presence of frass however, does not indicate whether the attack is active or not. Borer larvae cannot be sighted unless the susceptible timber is broken open.

IMPORTANT NOTE: As a delay may exist between the time of an attack and the appearance of telltale signs associated with the attack, it is possible that borer activity and damage exists though not discernible at the time of inspection.

Economic Significance Evidence of borer activity is rarely cause for alarm, but rather for careful consideration of three main points, namely the identification of the particular borer responsible, whether the infestation is still active, and the extent of the damage. Full consideration should be given to each of these items before any action is taken.

Property: 68 Barada Crescent, Aranda ACT 2614

The following wood borers cause damage most frequently encountered by building owners.

The Lyctid Borer The most common lyctid borer in Australia is **Lyctus brunneus (powder post beetle)**. Attack usually takes place during the first six to twelve months of the service life of timber. However, the powder post beetle is not considered a significant pest of timber and treatment of infestation is not usually required. As only the sapwood of certain hardwoods is destroyed, larger- dimensional timbers (such as rafters, bearers and joists) in a building are seldom weakened significantly to cause collapse. In small- dimensional timbers (such as tiling and ceiling battens) the sapwood may be extensive, and its destruction may cause collapse. This may require the support or replacement of the affected battens. Competent advice (e.g. from a licenses or registered building contractor) should be sought to determine the extent of any structural damage, and as to the need or otherwise for rectification or repair work.

The Anobiid Borer There are many different species of Anobiid borer, the most frequently encountered being *Anobium punctatum* (furniture beetle) and *Calymmaderus incisus* (Queensland pine beetle). Attack mainly occurs to softwoods especially pine timbers such as floorboards that have been in service for at least ten years. Should any structural timbers be attacked by Anobiid borers it is often difficult to determine what extent the borer damage has weakened such timbers and replacement is often the only way of ensuring safety from collapse.

In the case of Anobiid borers, once an attack is initiated it is unlikely to cease or die out of its own accord without some sort of eradication treatment. Therefore, unless proof of treatment is provided, evidence of an attack must always be considered active. Although a chemical treatment is an option, replacement of infested timbers with non-susceptible, or treated timber, is the most effective method of treatment. Before any option is considered, competent advice (e.g. from a licensed building contractor) should be sought to determine the extent of any structural damage, and as to the need or otherwise for rectification or repair work.

Other Borers: A further (more invasive) investigation is strongly recommended to determine whether infestation is still active and to positively identify the borer species responsible for the attack. Always seek further advice from the Consultant.

Management Program: Wherever practical, remove any conditions conducive to attack (e.g. *Anobium* borer thrive in badly ventilated subfloor areas). Regular inspections are recommended at intervals not exceeding 12 months. Always seek further advice from the Consultant.

Property: 68 Barada Crescent, Aranda ACT 2614

4. FUNGAL DECAY CAUSED BY WOOD DECAY FUNGI:

4.1. Evidence of damage caused by wood decay (rot) fungi was found.

- **Moderate timber decay was found in the base of some of the fence timbers, in the timber paling fences of the property.**
- **General weathering and timber decay was found in the several timbers in the hand rails, attached to the patio areas, and in one of the timber window frames, of the storeroom at the rear of the garage.**

NB. If any evidence of fungal decay or damage is reported, you should consult a building expert to determine the full extent of damage, and the estimated cost of repairs or timber.

General Description of Attack Decaying wood contains sufficient moisture to retain its original shape and may have sufficient strength to withstand normal loads. In contrast decayed wood is reduced both in moisture content and size as indicated by cracking either along or across the grain or fibres coming apart in a stringy manner. Decayed wood will have undergone considerable strength reduction.

Economic Significance Fungal decay can cause at one extreme, structural failure of the affected timber, and at the other purely superficial surface damage. The most critical determination is that of which timber is affected and decaying, because decay will most likely spread (unless sources of moisture are quickly removed). Affected and decayed timber may warrant timber replacement, but the rot should not spread unless a new moisture source becomes available in that area.

Where evidence of decayed timber exists, competent advice (e.g. from a licensed or registered building contractor) should be sought to determine the extent of any structural damage, and as to the need or otherwise for rectification or repair work. It is important to correct any condition conducive to attack prior to replacing decayed wood.

Where evidence of decaying timber exists, competent advice (e.g. from a licensed or registered building contractor) should be sought to remove the condition(s) conducive to attack, and to determine the extent of any structural damage, and as to the need or otherwise for rectification or repair work.

Where the full extent of damage or the overall condition of the timber is undetermined a further inspection is strongly recommended by a competent person (e.g. from a licensed or registered building contractor). This may require monitoring of the timber over a period of time and include the assessment of conditions conducive to attack in different weather conditions (e.g. to determine the adequacy of existing drainage).

Management Program Remove any conditions conducive to attack (e.g. lack of ventilation or the presence of excessive moisture). Regular inspections are recommended at intervals not exceeding 12 months. Always seek further advice from the Consultant.

5. CONDITIONS THAT ARE CONDUCTIVE TO TIMBER PESTS:

5.1. WATER LEAKS: At the time of the inspection no leaks were found to be present.

Water leaks, especially in or into the subfloor, or against the external walls; increase the likelihood of termite attack. Leaking showers or leaks from other 'wet areas' also increase the likelihood of concealed termite attack. Hot water overflows should be plumbed away from the building.

NB. We claim no expertise in building, and if any leaks were reported, you should consult a plumber or other building expert to determine the full extent of damage, and the estimated cost of repairs.

5.2. MOISTURE/DRAINAGE: At the time of the inspection moisture levels were normal.

Lack of Adequate Subfloor Ventilation Inadequate ventilation provides a condition suitable for timber pest infestation. For example, subterranean termites thrive in damp humid conditions typical of those provided in a poorly ventilated subfloor space. Where evidence of a lack of adequate ventilation has been identified in the report, the Client should seek competent advice (e.g. from a licensed or registered building contractor) in regard to upgrading ventilation. The Presence of Excessive Moisture Ground levels around the building should be maintained in such a way to minimise water entering under the building. Also the ground surface in subfloor areas should be kept graded to ensure that moisture does not pond or accumulate in any area. Where necessary, sub-surface drains should be installed and maintained to assist with drainage around and under the building. Likewise, the presence of excessive moisture can often be directly related to ventilation limitations and the resultant high humidity. Also, plumbing oversights and defects such as a leaking drain or tap will provide a microclimate conducive to timber pest attack. Where necessary, the Client should seek competent advice (e.g. from a licensed or registered plumbing contractor) to determine the adequacy of existing drainage and remove any conditions conducive to the presence of excessive moisture. The building may need to be monitored over a period of time to detect or confirm a damp problem. The presence of dampness (including moisture) is not always consistent as the prevailing and recent weather conditions at the time an inspection is carried out may affect the detection of damp problems. Importantly, precipitation at or near the time of inspection does not necessarily guarantee that a damp problem will automatically be evident due to such circumstances as prevailing wind conditions or intensity of rainfall. The absence of any dampness at the time of inspection does not necessarily mean the building will not experience some damp problems in other weather conditions. Likewise whether or not services have been used for some time prior to an inspection being carried out will affect the detection of dampness.

5.3. VENTILATION: Adequate.

Lack of Adequate Subfloor Ventilation Inadequate ventilation provides a condition suitable for timber pest infestation. For example, subterranean termites thrive in damp humid conditions typical of those provided in a poorly ventilated subfloor space. Where evidence of a lack of adequate ventilation has been identified in the report, the Client should seek competent advice (e.g. from a licensed or registered building contractor) in regard to upgrading ventilation.

Property: 68 Barada Crescent, Aranda ACT 2614

5.4. HOT WATER SERVICES AND AIR CONDITIONING UNITS: There is no need for this work to be carried out.

Hot water services and air conditioning units which release water alongside or near to building walls should be piped to a drain (if not possible then several metres away from the building), as the resulting wet area is highly conducive to termites.

5.5. SLAB EDGE EXPOSURE: The slab edge inspection zone does not apply to this property.

Where external concrete slab edges are not exposed, there is a high risk of concealed termite entry.

In some buildings built since July 1995, the edge of the slab forms part of the termite shield system. In these buildings an Inspection zone of at least 75mm should be maintained to permit detection of termite entry. The edge should not be concealed by render, tiles, cladding, flashings, adjoining structures, paving, soil, turf or landscaping etc. Where this is the case you should arrange to have the slab edge exposed for Inspection.

Concealed termite entry may already be taking place, but could not be detected at the time of the Inspection. This may have resulted in concealed timber damage.

NB. A very high proportion of termite attacks are over the slab edge. Covering the slab edge makes concealed entry easy. This is particularly true of infill type slab construction. Termite activity and/or damage may be present in concealed timbers of the building. We strongly recommend frequent regular inspections in accordance with AS 3660.2.

5.6. WEEP HOLES IN EXTERNAL WALLS: Weep holes are not applicable to this property.

It is very important that soil, lawn, concrete paths or pavers do not cover the weep holes. Sometimes, they have been covered during the rendering of the brick work. They should be clean and free flowing, and covering the weep holes in part or in whole may allow undetected termite entry.

5.7. TERMITE SHIELDS: Inadequate as ant capping is not continuous.

Termite Shields (Ant Caps) should be in good order and condition so termite workings are exposed and visible. This helps prevent termites from gaining undetected entry. Joins in the shielding should have been soldered during the installation. If it is observed that the joins in the shielding have not been soldered, then the shielding must be reported as inadequate. It may be possible for a builder to repair the shielding. If not, a chemical treated zone may need to be installed to deter termites from gaining concealed access to the building. Missing, damaged or poor shields increase the risk of termite infestation. If considered inadequate, a builder or other building expert should be consulted.

Other physical shield systems are not visible to inspection and no comment is made on such systems.

Property: 68 Barada Crescent, Aranda ACT 2614

5.8. BRIDGING OR BREACHING OF TERMITE BARRIERS AND INSPECTION ZONES: No bridging or breaching was found.

“Bridging” is the spanning of a termite barrier or inspection zone so that subterranean termites are provided with passage over or around that barrier. “Breaching” is the making of a hole or gap in a termite barrier so that termites are provided with a passage through that barrier.

5.9 OTHER AREA(S) AND/OR SITUATIONS THAT APPEAR CONDUCTIVE TO (MAY ATTRACT) SUBTERRANEAN TERMITE INFESTATION: The medium to large eucalypt trees within a 50 metre radius of the property, due to the nesting conditions. The landscaped hardwood timbers, due to the food source.

6.0. OVERALL ASSESSMENT OF THE PROPERTY:

6.1. Where evidence of live termites, termite damage or termite workings (mudding) was found in the building(s) then the risk of a further attack is extremely high.

Where evidence of live termites, termite damage or termite workings was found in the grounds but not in the building(s) then the risk to buildings must be reported as high to extremely high.

6.2. At the time of the Inspection, the degree of risk of subterranean termite infestation to the overall property was considered to be **Extremely High**.

6.3. Subterranean Termite Treatment Recommendation: A management program in accordance with AS 3660-2000 to protect against subterranean termites is considered **essential as live Termites were found**.

6.4. Future Inspections: AS 3660.0-2000 recommends “regular competent Inspections should be carried out at least on an annual basis, but more frequent Inspections are strongly recommended”.

It goes on to inform that “regular Inspections will not prevent termite attack, but may help in the detection of termite activity. Early detection will allow remedial treatment to be commenced sooner, and damage to be minimized”.

Due to the degree of risk of subterranean termite infestation noted above and all other findings of this Report; we strongly recommend that a full Inspection and written Report in accordance with AS 4349.3 or AS 3660.2-2000 is conducted at this property every 6 months, but no more than 12 months.

Property: 68 Barada Crescent, Aranda ACT 2614

DEFINITIONS:

Timber Pest Attack: Means Timber Pest Activity and/or Timber Pest Damage.

Timber Pest Activity: Means telltale signs associated with 'active' (live) and/or 'inactive' (absence of live) Timber Pests at the time of inspection.

Timber Pest Damage: Means noticeable impairments to the integrity of timber and other susceptible materials resulting from attack by Timber Pests.

Major Safety Hazard: Means any item that may constitute an immediate or imminent risk to life, health or property resulting directly from Timber Pest Attack. Occupational, health and safety or any other consequence of these hazards has not been assessed.

Conditions Conducive to Timber Pest Attack: Means noticeable building deficiencies or environmental factors that may contribute to the presence of Timber Pests.

Readily Accessible Areas: Means areas which can be easily and safely inspected without injury to person or property, are up to 3.6 metres above ground or floor levels, in roof spaces where the minimum area of accessibility is not less than 600 mm high by 600 mm wide and subfloor spaces where the minimum area of accessibility is not less than 400 mm high by 600 mm wide, providing the spaces or areas permit entry. The term 'readily accessible' also includes: accessible subfloor areas on a sloping site where the minimum clearance is not less than 150 mm high, provided that the area is not more than 2 metres from a point with conforming clearance (i.e. 400 mm high by 600 mm wide); and areas at the eaves of accessible roof spaces that are within the consultant's unobstructed line of sight and within arm's length from a point with conforming clearance (i.e. 600 mm high by 600 mm wide).

Client: Means the person or persons for whom the Timber Pest Detection Report was carried out or their Principal (i.e. the person or persons for whom the report was being obtained).

Timber Pest Detection Consultant: Means a person who meets the minimum skills requirement set out in the current Australian Standard AS 4349.3 Inspections of Buildings. Part 3: Timber Pest Inspection Reports or state/territory legislation requirements beyond this Standard, where applicable.

Property: 68 Barada Crescent, Aranda ACT 2614

Building and Site: Means the main building (or main buildings in the case of a building complex) and all timber structures (such as outbuildings, landscaping, retaining walls, fences, bridges, trees and stumps with a diameter greater than 100 mm and timber embedded in soil) and the land within the property boundaries up to a distance of 50 metres from the main building(s).

Timber Pests: Means one or more of the following wood destroying agents which attack timber in service and affect its structural properties:

Chemical Delignification: The breakdown of timber through chemical action.

Fungal Decay: The microbiological degradation of timber caused by soft rot fungi and decay fungi, but does not include Mould, which is a type of fungus that does not structurally damage wood.

Wood Borers: Wood destroying insects belonging to the order 'Coleoptera' which commonly attack seasoned timber.

Termites: Wood destroying insects belonging to the order 'Isoptera' which commonly attack seasoned timber.

Tests: Means additional attention to the visual examination was given to those accessible areas which the consultant's experience has shown to be particularly susceptible to attack by Timber Pests. Instrument testing of those areas and other visible accessible timbers/materials/areas showing evidence of attack was performed.

Instrument Testing: Means where appropriate the carrying out of Tests using the following techniques and instruments:

(a) Electronic moisture detecting meter - an instrument used for assessing the moisture content of building elements;

(b) Stethoscope - an instrument used to hear sounds made by termites within building elements;

(c) Probing - a technique where timber and other materials/areas are penetrated with a sharp instrument (e.g. bradawl or pocket knife), but does not include probing of decorative timbers or finishes, or the drilling of timber and trees; and

(d) Sounding - a technique where timber is tapped with a solid object.

Property: 68 Barada Crescent, Aranda ACT 2614

IMPORTANT MAINTENANCE ADVICE REGARDING INTEGRATED PEST MANAGEMENT FOR PROTECTING AGAINST TIMBER PESTS:

You should read and understand the following important information. It will help explain what is involved in a Timber Pest Inspection, the difficulties faced by a Timber Pest Inspector, and why it is not possible to guarantee that a property is free of Timber Pests. It also details important information about what you can do to help protect your property from Timber Pests. This information forms an integral part of the Report. Any structure can be attacked by Timber Pests. Periodic maintenance should include measures to minimise possibilities of infestation in and around a property. Factors which may lead to infestation from Timber Pests include situations where the edge of the concrete slab is covered by soil or garden debris, filled areas, areas with less than 400mm clearance, foam insulation at foundations, earth/wood contact, damp areas, leaking pipes, etc.; form-work timbers, scrap timber, tree stumps, mulch, tree branches touching the structure, wood rot, etc. Gardens, pathways or turf abutting or concealing the edge of a concrete slab will allow for concealed entry by timber pests any timber in contact with soil such as form-work, scrap timbers or stumps must be removed from under and around the buildings and any leaks repaired. You should endeavor to ensure such conditions DO NOT occur around your property. We further advise that you engage a professional pest control firm to provide a termite management program in accord with AS 3660 to minimise the risk of termite attack. There is no way of preventing termite attack. Even AS 3660 advises that "the provision of a complete termite barrier will impede and discourage termite entry into a building. It cannot prevent termite attack Termites can still bridge or breach barriers but they can be detected more readily during routine inspections."

REASONABLE ACCESS:

Unless specified in writing, the inspection only covered the Readily Accessible Areas of the Building and Site.

The inspection did not include areas which were inaccessible, not readily accessible or obstructed at the time of inspection. Areas which are not normally accessible were not inspected and include - but not limited to – inside walls, the interior of a flat roof or beneath a suspended floor filled with earth.

Building Interior the Consultant did not move or remove any ceilings, wall coverings, flooring, floor coverings (including carpeting), furnishing, equipment, appliances, pictures or other household goods. In an occupied property, furnishings or household items may be concealing evidence of timber pest attack which may only be revealed when the items are moved or removed.

Building Exterior, Roof Exterior and Site The Consultant did not move or remove any obstructions such as wall cladding, awnings, trellis, earth, plants, bushes, foliage, stored materials, debris or rubbish. Due to the 'secretive' nature of timber pests, it is possible that hidden damage may exist in concealed areas, e.g. wall framing. Damage may only be found when the obstruction is removed. In the case of buildings constructed on concrete slabs, if the edge of the slab or any weep hole or vent at the base of external walls is concealed by pavements, gardens, lawns or landscaping then it is possible for termites to gain undetected entry into the building. The building of gardens or planting of shrubs close to the perimeter of the building can promote and conceal termite entry points. The storage of cellulose materials such as

Property: 68 Barada Crescent, Aranda ACT 2614

building materials and firewood in close proximity to the ground or building may encourage termite activity.

Roof Space Obstructions such as roofing, stored articles, thermal insulation, sarking and pipe/duct work may be concealing evidence of timber pest attack which may only be revealed when the obstructions are moved or removed. Also, bodily access should be provided to the interior of all accessible roof spaces. In accordance with Australian Standard ASS 4349 the minimum requirement is a 400mm by 500 mm access manhole.

Subfloor Space Subfloor areas should be kept free from all vegetation (including tree stumps) and other cellulose material which may encourage timber pest activity. Also, storage of materials in subfloor areas is not recommended as it reduces ventilation and makes inspection difficult. Obstructions may be concealing evidence of timber pest attack which may only be revealed when the obstructions are moved or removed. Bodily access should be provided to all accessible subfloor areas with the minimum requirement being a 500 mm x 400 mm access manhole. In the case of suspended floors, if the clearance between the ground and structural components is less than 400 mm, then the ground should be excavated to provide the required clearance, subject to maintaining adequate drainage and support to footings. If the subfloor has been sprayed for subterranean termites or if the area is susceptible to mould growth, appropriate health precautions must be followed before entering the area. Also, special care should be taken not to disturb the treated soil. Always seek further advice from the Consultant.

A further inspection is strongly recommended of those areas that were not readily accessible and of inaccessible or obstructed areas once access has been provided or the obstruction removed. This will involve a separate visit to the site, permission from the owner of the property and additional cost.

Unless stated otherwise, any recommendation or advice given in this Report should be implemented as a matter of urgency.

Property: 68 Barada Crescent, Aranda ACT 2614

A MORE INVASIVE PHYSICAL INSPECTION IS AVAILABLE AND RECOMMENDED:

As detailed above, there are many limitations to this visual Inspection only. With the permission of the owner of the premises we WILL perform a more invasive physical inspection that involves moving or lifting: insulation, stored items, furniture or foliage during the inspection. We WILL physically touch, tap, test and when necessary force/gouge suspected accessible timbers. We WILL gain access to areas, where physically possible and considered practical and necessary, by way of cutting traps and access holes.

This style of Report is available by ordering with several days' notice. Inspection time for this style of Report will be greater than for a VISUAL INSPECTION.

It involves disruption in the case of an occupied property, and some permanent marking is likely. You must arrange for the written permission of the owner who must acknowledge all the above information and confirm that our firm will not be held liable for any damage caused to the property.

A price is available on request.

CONCRETE SLAB HOMES:

Homes constructed on concrete slabs pose special problems with respect to termite attack. If the edge of the slab is concealed by concrete paths, patios, pavers, garden beds, lawns, foliage, etc. then it is possible for termites to affect concealed entry into the property, and they can then cause extensive damage to concealed framing timbers. Even the most experienced Inspector may be unable to detect their presence due to concealment by wall linings. Only when the termites attack timbers in the roof void, which may in turn be concealed by insulation, can their presence be detected. Where termite damage is located in the roof, it should be expected that concealed framing timbers will be extensively damaged. With a concrete slab home it is imperative that you expose the edge of the slab and ensure that foliage and garden beds do not cover the slab edge. Weep holes must be kept free of obstructions.

It is strongly recommended that you have a Termite Inspection in accordance with AS 3660.2 carried out every 6 to 12 months.

SUBTERRANEAN TERMITES:

No property is safe from termites.

General Description of Attack Timber hollowed beneath; some cracking at the surface of timber; earthen channels present; or pale faecal spots present.

IMPORTANT NOTE As a delay may exist between the time of an attack and the appearance of telltale signs associated with the attack, it is possible that termite activity and damage exists though not discernible at the time of inspection.

Treatment After discovery of an active infestation, it is imperative that the species of termite is accurately identified before costly (and sometimes unnecessary or inappropriate) methods of treatment

Property: 68 Barada Crescent, Aranda ACT 2614

are initiated. Only economically important species which are known to attack timber structures should be treated.

In the case of economically important species, it is important that the termite workings are not further disturbed until the proposed method of control has been determined by a licensed pest control operator. Premature attempts to repair or replace infested timber may cause the termites to withdraw from the area temporarily, thereby hindering effective treatment. Any repair or replacement of infested timber should be carried out after the appropriate treatment has been completed.

Where evidence of active termites is detected within a building or within 50 metres of any building, it must always be assumed that the termites may also be active in areas of the property not inspected. Accordingly, where the termites are known to be of economic significance, a further (more invasive) inspection is strongly recommended of areas which were inaccessible, not readily accessible or obstructed at the time of inspection.

Termite Workings and Damage Where evidence of damage to building timbers exists, competent advice (e.g. from a licensed or registered building contractor) should be obtained to determine the extent of any structural damage and as to the need or otherwise for rectification or repair work.

Where evidence of inactive termites is located within the building, it is possible that termites are still active in areas of the property not inspected and they may continue to cause damage. A further more invasive inspection is strongly recommended of areas which were inaccessible, not readily accessible or obstructed at the time of inspection.

Where evidence of an inactive termite infestation exists, it is not possible, without benefit of further investigation and inspections over a period of time, to ascertain whether any infestation is active or inactive. Continued, regular, inspections are essential.

Where evidence of termite attack exists to any trees or tree stumps a more conclusive search should be undertaken. This may require the tree or stump to be drilled to determine the existence of a termite nest. In addition, the soundness and stability of any standing trees identified as being affected by termite attack should be confirmed. Always seek further advice from the Consultant.

Previous Treatments Where evidence of a possible termite treatment was located, the Client should obtain and keep on file all relevant documents pertaining to the extent of the treatment, any service warranties and advice in regard to the building owner's obligation to maintain the treatment and/or barrier. If evidence of a previous treatment of termite infestation is noted, and appropriate documentation is not available, the Client must assume that the termite infestation may still be active in areas of the property not inspected. Accordingly, a re-treatment may be required. Always seek further advice from the Consultant.

Frequency of Future Inspections Australian Standard AS 3660 recognises that regular inspections will not prevent termite attack, but may help in the detection of termite activity. Early detection will allow remedial treatment to be commenced sooner and damage to be minimised.

Property: 68 Barada Crescent, Aranda ACT 2614

Inspections at intervals not exceeding twelve (12) months are recommended. Where the termite risk is high or the building type susceptible to termite attack, more frequent inspections (3-6 months) should be undertaken.

RISK MANAGEMENT OPTIONS:

To help protect against financial loss, it is essential that the building owner immediately control or rectify any evidence of destructive timber pest activity or damage identified in this inspection report. The Client should further investigate any high risk area where access was not gained. It is strongly advised that appropriate steps be taken to remove, rectify or monitor any evidence of conditions conducive to timber pest attack.

To help minimise the risk of any future loss, the Client should consider whether the following options to further protect their investment against timber pest infestation are appropriate for their circumstances:

Undertake thorough regular inspections at intervals not exceeding twelve months or more frequent inspections where the risk of timber pest attack is high or the building type is susceptible to attack. To further reduce the risk of subterranean termite attacks implement a management program in accordance with Australian Standard AS 3660. This may include the installation of a monitoring and/or baiting system, or chemical and/or physical barrier. However, AS 3660 stresses that subterranean termites can bridge or breach barrier systems and inspection zones and that thorough regular inspection of the building are necessary.

CONTACT THE INSPECTOR:

Please feel free to contact the Inspector who carried out this inspection. Often it is very difficult to fully explain situations, problems, access difficulties or timber pest activity and/or damage in a manner that is readily understandable by the reader. Should you have any difficulty in understanding anything contained within this Report, then you should immediately contact the Inspector and have the matter explained to you.

If you have any questions at all or require any clarification then contact the Inspector prior to acting on this Report.

The Inspection and Report was carried out by: Mark DeVries - 0419249643

Date –Friday, 17 April 2015

SIGNED FOR AND ON BEHALF OF:

ACT Property Inspections
PO Box 576
Erindale Centre ACT 2903

Signature:

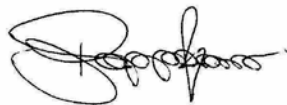

Notice to the Purchaser

- a) Prior to or on Exchange, and prior to the commencement of the 'Cooling-off Period', you were given an Inspection Report on the Property you intend on purchasing ("the Report"). The Purchaser is advised that this Report reflects the condition of the property existing at the time of the Inspection (Inspection Date) and may not reflect the current state. Timber Pests, particularly Termites, may have gained entry to the property since the Inspection Date. Termites can, in a relatively short period, cause significant damage to both structural and non-structural timbers within and around the buildings of the Property. Termites (white ants) may be difficult to detect and much of the damage caused may not be readily visible. If damage exists then it may cost thousands of dollars to repair.

It is, therefore, very strongly recommended that you urgently arrange for another Inspection and Report in accordance with AS4349.3 to be carried out prior to exchange, or prior to the expiration of any 'Cooling off Period', and prior to settlement.

- b) If the Report indicated the presence of Termites, termite damage or recommends any treatments or other Inspections and Reports, you should obtain copies of the treatment proposal, any certificates of treatments carried out, details of all repairs including copies of quotations, invoices and any other Reports.

It is strongly recommended that you arrange for an Inspection and Report in accordance with AS 4349.3 to verify that the treatment has been successful and carried out in accordance with AS 3660.2 and a further building Inspection in accordance with AS 4349.1.

- c) If you fail to procure a further Inspection and report as recommended in (a) and (b), or fail to obtain copies of the treatment proposal, certificates of treatment carried out, details of all repairs including copies of quotations, invoices and any other reports as recommended in (b) above, then it will be deemed that you have decided not to have a further Inspection and report carried out, or to obtain copies of certificates of treatments carried out, details of all repairs including copies of quotations, invoices and any other reports.

It will be deemed that you have relied upon your own enquiries and the report, knowing the possible consequences and that the condition of the property, as stated in the report, may have changed.

- d) The person carrying out the Inspection and the company, partnership or sole trader that employs that person will have no liability to you for any damage or loss you may suffer as a result of your entering the contract to purchase the property or in connection with completing the purchase of the property as a result of your failure to heed the advice given in (a) and (b) and the warning contained in (c) above, and may use such failure in defence of any claim that you may later make against any of them.

Property: 68 Barada Crescent, Aranda ACT 2614

Limited Liability to a Purchaser within the Australian Capital Territory

This Report is made solely for the use and benefit of the Client. The Consultant is not liable for any reliance placed on this report by any third party. However, within the ACT only and in accordance with the Civil Law (Sale of Residential Property) Act 2003 and the Civil Law (Sale of Residential Property) Regulations 2004, a copy of the report must be attached to the Contract for Sale and may in certain circumstances be relied upon by the Purchaser of residential property.

The circumstances in which a Purchaser of residential property within the ACT may rely on this report in respect of the state of the property at the time of the inspection are as follows:

- (a) The inspection was carried out no earlier than three months before the day the property was first advertised or offered for sale or listed by an agent; and
- (b) The date on which the contract was entered into was not more than 180 days after the date of the inspection; and
- (c) The report is provided to the Purchaser prior to or at the time the Contract for Sale is entered into between the Purchaser and vendor.
- (d) The service requested is the Standard Inspection Report.

Important Asbestos Advice for ACT homes built before 1985

Asbestos is hazardous but it can be managed safely.

Follow the three steps for managing materials containing asbestos (MCAs) in your home.

Step 1. Identify where MCAs may be in your home

When was your house built?

- If your house was built before 1985, the table below gives you an indication of where you are likely to find MCAs in your home. There is also a diagram on the back of this sheet showing where MCAs are commonly found.
- If your house was built after 1985, it is unlikely to contain MCAs.
- If in doubt, assume that materials DO contain asbestos.

Common locations of MCAs in ACT homes*

(Percentage (%) of properties sampled where asbestos was detected)

Location	Pre 1965	1965–1979	1980–1984	1985–now [#]
Eaves	86%	92%	40%	0%
Garage/shed	80%	70%	15%	0%
Bathroom	54%	75%	50%	0%
Laundry	75%	80%	50%	0%
Kitchen	52%	23%	15%	0%

*Results of 2005 Asbestos Survey of over 600 ACT Homes. [#]One MCA was found in a 1985 house supporting roof tiles on a gable end.

Step 2. Assess the risk

Visually check the condition of the MCA – is it cracked, broken, etc?

- If it's in good condition and left undisturbed, it does not pose a health risk.
- If you suspect it is not in good condition, arrange for appropriate maintenance or removal by a qualified person.

Step 3. Manage safely

Make sure you remember to:

- Keep an eye on MCAs to make sure they remain in good condition.
- Consider removal of the MCA by a qualified person, when renovating or doing home repairs.
- Inform tradespeople working on your home of the location of any possible MCAs.
- Engage a qualified person if you decide to obtain a professional asbestos report on MCAs in your home.

For further information or advice on managing asbestos or home renovations visit the asbestos website www.asbestos.act.gov.au or call 13 22 81.



Asbestos Awareness.
Helping everyone breathe easier.

Common locations of materials containing asbestos in ACT homes

If your house was built before 1985, some of the materials it was built from probably contain asbestos.



Garages, carports, sheds and dog kennels

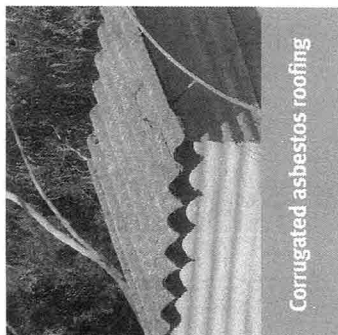

Corrugated asbestos roofing

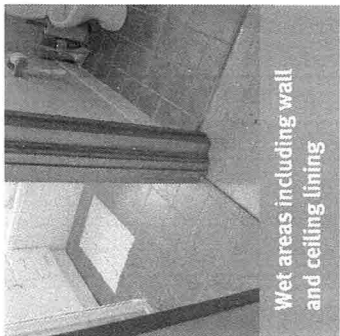

Wet areas including wall and ceiling lining

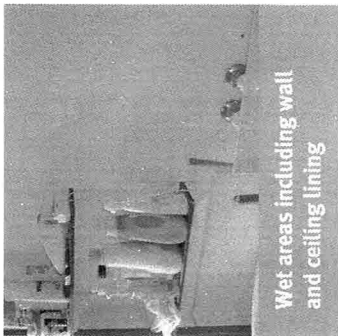

Wet areas including wall and ceiling lining

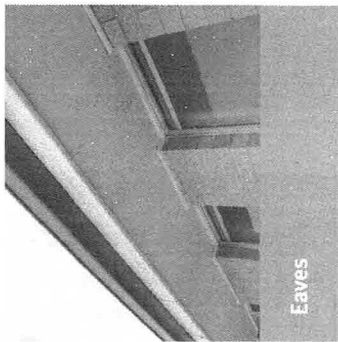

Eaves

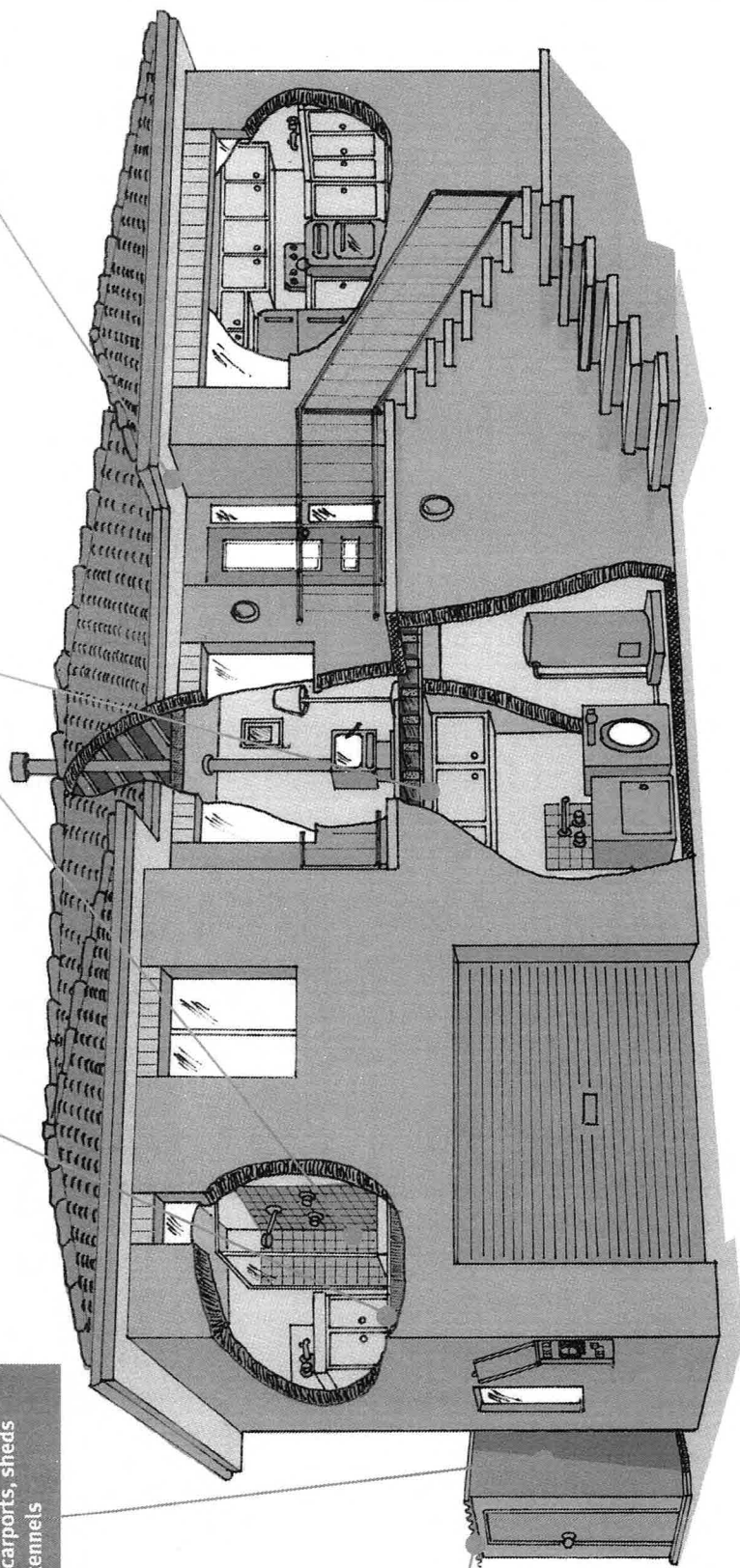

Asbestos Awareness.

Helping everyone breathe easier.



Pest Controllers Combined Liability Certificate of Currency

The Policy below is current until 4.00pm on the expiry date shown below

INSURED:	ACT Property Inspections Pty Ltd ACT Pest Management Pty Ltd
BUSINESS DESCRIPTION:	General Pest & Weed Control - Covered Timber Pest Inspections - Covered Termite Barrier Installations - Covered Pre-Purchase House Pest Inspections - Covered Fumigation - Covered Building Inspections (Non Pest Related) - Covered Energy Efficiency Ratings - Covered Compliance Reports – Covered
POLICY REFERENCE:	09 A349653 PLB
EXPIRY DATE:	28/03/2016
POLICY CLASS:	Pest Controllers Combined Liability.
SUMS INSURED:	Section A: Broadform Liability Limit of Liability: \$10,000,000 any one claim, or loss, including defence costs, and in the aggregate in respect of all claims, or losses, including defence costs. Section B: Professional Indemnity Limit of Liability: \$1,000,000 any one claim, or loss, including defence costs, and in the aggregate in respect of all claims, or losses, including defence costs.

This Certificate of Currency is subject to the Policy Documentation to be read in conjunction with the Definitions, Conditions and Exclusions in the Pest Controllers Combined Liability Insurance Policy - QM792.

Dated issued: 17/03/2015



ACT Property Inspections Pty Ltd

PO Box 576
Erindale Centre ACT 2903
Australia
Phone: 0262922278
ABN: 33 600 397 466

Invoice: 12934

Tax Invoice

Invoice date: 09/04/2015

Bill to:
Robert Galloway
68 Barada Crescent, Aranda ACT 2614

Due:
14/04/2015

ITEM	DESCRIPTION		UNITS	UNIT PRICE (inc GST)	TAX TYPE	AMOUNT (inc GST)
1.0	ACTPLA Fees - No GST	Qty	1	139.30	GST Free	139.30
1.1	Property Report	Qty	1	750.70	GST	750.70
1.2	Energy Efficiency Report (Complimentary)	Qty	1	0.00	GST	0.00

GST: \$68.25
 Total (inc GST): \$890.00
 Amount Paid: \$890.00
AMOUNT DUE: \$0.00

Notes

Paid in full 13/4/15. Thank you for your payment.

How to pay



Bank Deposit

Bank Name: ANZ
BSB: 012084
Account Number: 194679655
Account Name: ACT Property Inspections Pty Ltd
Reference: 12934



Mail

Make your cheque payable to:
 ACT Property Inspections Pty Ltd

Detach this section and mail with your cheque to:
 PO Box 576
 Erindale Centre ACT 2903